

# MOSFET

## 650V CoolMOS™ CFD7A SJ Power Device

650V CoolMOS™ CFD7A is Infineon's latest generation of market leading automotive qualified high voltage CoolMOS™ MOSFETs. In addition to the well-known attributes of high quality and reliability required by the automotive industry, the new CoolMOS™ CFD7A series provides for an integrated fast body diode and can be used for PFC and resonant switching topologies like the ZVS phase-shift full-bridge and LLC.

### Features

- Latest 650V automotive qualified technology with integrated fast body diode on the market featuring ultra low  $Q_{rr}$
- Lowest FOM  $R_{DS(on)} * Q_g$  and  $R_{DS(on)} * E_{oss}$
- 100% avalanche tested
- Kelvin source contact available
- Best-in-class  $R_{DS(on)}$  in SMD and THD packages

### Benefits

- Optimized for higher battery voltages up to 475 V thanks to further improved robustness
- Lower switching losses enabling higher switching frequencies
- High quality and reliability
- Advanced controllability due to kelvin source
- Increased package creepage distance
- Increased efficiency in light load and full load conditions

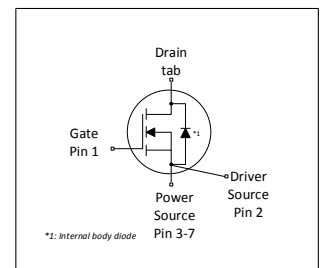
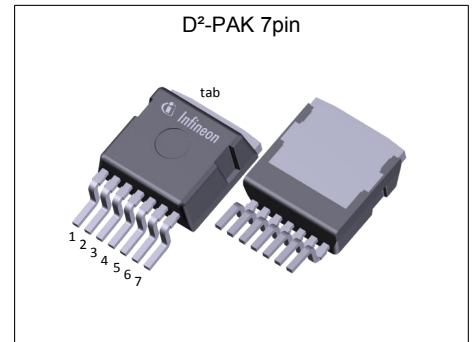
### Potential applications

- Suitable for PFC and DC-DC stages for:
- Unidirectional and bidirectional DC-DC converters,
  - On-Board battery Chargers

### Product validation

Qualified according to AEC Q101

*Please note: The source and sense source pins are not exchangeable. Their exchange might lead to malfunction. For production part approval process (PPAP) release we propose to share application related information during an early design phase to avoid delays in PPAP release. Please contact Infineon sales office.*



**Table 1 Key Performance Parameters**

Parameter	Value	Unit
$V_{DS}$	650	V
$R_{DS(on),max}$	75	mΩ
$Q_{g,typ}$	68	nC
$I_{D,pulse}$	139	A
$E_{oss} @ 400V$	8.8	μJ
Body diode $di_F/dt$	1300	A/μs

Type / Ordering Code	Package	Marking	Related Links
IPBE65R075CFD7A	PG-TO263-7-11	65A075F7	see Appendix A

## Table of Contents

Description .....	1
Maximum ratings .....	3
Thermal characteristics .....	4
Electrical characteristics .....	5
Electrical characteristics diagrams .....	7
Test Circuits .....	11
Package Outlines .....	12
Appendix A .....	13
Revision History .....	14
Trademarks .....	14
Disclaimer .....	14

**1 Maximum ratings**  
 at  $T_j = 25^\circ\text{C}$ , unless otherwise specified

**Table 2 Maximum ratings**

Parameter	Symbol	Values			Unit	Note / Test Condition
		Min.	Typ.	Max.		
Continuous drain current <sup>1)</sup>	$I_D$	-	-	32 20	A	$T_C=25^\circ\text{C}$ $T_C=100^\circ\text{C}$
Pulsed drain current <sup>2)</sup>	$I_{D,pulse}$	-	-	139	A	$T_C=25^\circ\text{C}$
Avalanche energy, single pulse	$E_{AS}$	-	-	164	mJ	$I_D=5.1\text{A}$ ; $V_{DD}=50\text{V}$ ; see table 10
Avalanche current, single pulse	$I_{AS}$	-	-	5.1	A	-
MOSFET dv/dt ruggedness	dv/dt	-	-	120	V/ns	$V_{DS}=0\dots400\text{V}$
Gate source voltage (static)	$V_{GS}$	-20	-	20	V	static;
Gate source voltage (dynamic)	$V_{GSk,pulse}$	-30	-	30	V	$f_{repetition} \leq 100\text{kHz}$ , $t_{pulse} \leq 2\text{ns}$
Power dissipation	$P_{tot}$	-	-	171	W	$T_C=25^\circ\text{C}$
Storage temperature	$T_{stg}$	-55	-	150	$^\circ\text{C}$	-
Operating junction temperature	$T_j$	-40	-	150	$^\circ\text{C}$	-
Mounting torque	-	-	-	-	Ncm	-
Continuous diode forward current	$I_S$	-	-	32	A	$T_C=25^\circ\text{C}$
Diode pulse current <sup>2)</sup>	$I_{S,pulse}$	-	-	139	A	$T_C=25^\circ\text{C}$
Reverse diode dv/dt <sup>3)</sup>	dv/dt	-	-	70	V/ns	$V_{DS}=0\dots400\text{V}$ , $I_{SD} \leq 16.4\text{A}$ , $T_j=25^\circ\text{C}$ see table 8
Maximum diode commutation speed	$di_f/dt$	-	-	1300	A/ $\mu\text{s}$	$V_{DS}=0\dots400\text{V}$ , $I_{SD} \leq 16.4\text{A}$ , $T_j=25^\circ\text{C}$ see table 8

1) Limited by  $T_{j,max}$ .

2) Pulse width  $t_p$  limited by  $T_{j,max}$

3) Identical low side and high side switch with identical  $R_\theta$

## 2 Thermal characteristics

**Table 3 Thermal characteristics**

Parameter	Symbol	Values			Unit	Note / Test Condition
		Min.	Typ.	Max.		
Thermal resistance, junction - case	$R_{thJC}$	-	-	0.73	°C/W	-
Soldering temperature, reflow soldering allowed	$T_{sold}$	-	-	260	°C	reflow MSL1

### 3 Electrical characteristics

at  $T_j=25^\circ\text{C}$ , unless otherwise specified

**Table 4 Static characteristics**

For applications with applied blocking voltage > 475 V, it is required that the customer evaluates the impact of cosmic radiation effect in early design phase and contacts the Infineon sales office for the necessary technical support by Infineon.

Parameter	Symbol	Values			Unit	Note / Test Condition
		Min.	Typ.	Max.		
Drain-source breakdown voltage	$V_{(BR)DSS}$	650	-	-	V	$V_{GS}=0V, I_D=1mA$
Gate threshold voltage <sup>1)</sup>	$V_{(GS)th}$	3.5	4	4.5	V	$V_{DS}=V_{GS}, I_D=0.82mA$
Zero gate voltage drain current	$I_{DSS}$	-	-	1	$\mu A$	$V_{DS}=650V, V_{GS}=0V, T_j=25^\circ C$ $V_{DS}=650V, V_{GS}=0V, T_j=150^\circ C$
Gate-source leakage current	$I_{GSS}$	-	-	0.1	$\mu A$	$V_{GS}=20V, V_{DS}=0V$
Drain-source on-state resistance	$R_{DS(on)}$	-	0.062 0.139	0.075 -	$\Omega$	$V_{GS}=10V, I_D=16.4A, T_j=25^\circ C$ $V_{GS}=10V, I_D=16.4A, T_j=150^\circ C$
Gate resistance	$R_G$	-	5.8	-	$\Omega$	$f=250kHz$ , open drain

**Table 5 Dynamic characteristics**

External parasitic elements (PCB layout) influence switching behavior significantly.

Stray inductances and coupling capacitances must be minimized.

For layout recommendations please use provided application notes or contact Infineon sales office.

Parameter	Symbol	Values			Unit	Note / Test Condition
		Min.	Typ.	Max.		
Input capacitance	$C_{iss}$	-	3288	-	pF	$V_{GS}=0V, V_{DS}=400V, f=250kHz$
Output capacitance	$C_{oss}$	-	46	-	pF	$V_{GS}=0V, V_{DS}=400V, f=250kHz$
Effective output capacitance, energy related <sup>2)</sup>	$C_{o(er)}$	-	110	-	pF	$V_{GS}=0V, V_{DS}=0...400V$
Effective output capacitance, time related <sup>3)</sup>	$C_{o(tr)}$	-	1152	-	pF	$I_D=constant, V_{GS}=0V, V_{DS}=0...400V$
Turn-on delay time	$t_{d(on)}$	-	24	-	ns	$V_{DD}=400V, V_{GS}=13V, I_D=16.4A,$ $R_G=5.3\Omega$ ; see table 9
Rise time	$t_r$	-	4	-	ns	$V_{DD}=400V, V_{GS}=13V, I_D=16.4A,$ $R_G=5.3\Omega$ ; see table 9
Turn-off delay time	$t_{d(off)}$	-	92	-	ns	$V_{DD}=400V, V_{GS}=13V, I_D=16.4A,$ $R_G=5.3\Omega$ ; see table 9
Fall time	$t_f$	-	3	-	ns	$V_{DD}=400V, V_{GS}=13V, I_D=16.4A,$ $R_G=5.3\Omega$ ; see table 9

<sup>1)</sup> We do not recommend using the CoolMOS mentioned in this datasheet to operate in "linear mode". For assessment of potential "linear mode", please contact Infineon sales office.

<sup>2)</sup>  $C_{o(er)}$  is a fixed capacitance that gives the same stored energy as  $C_{oss}$  while  $V_{DS}$  is rising from 0 to 400V

<sup>3)</sup>  $C_{o(tr)}$  is a fixed capacitance that gives the same charging time as  $C_{oss}$  while  $V_{DS}$  is rising from 0 to 400V

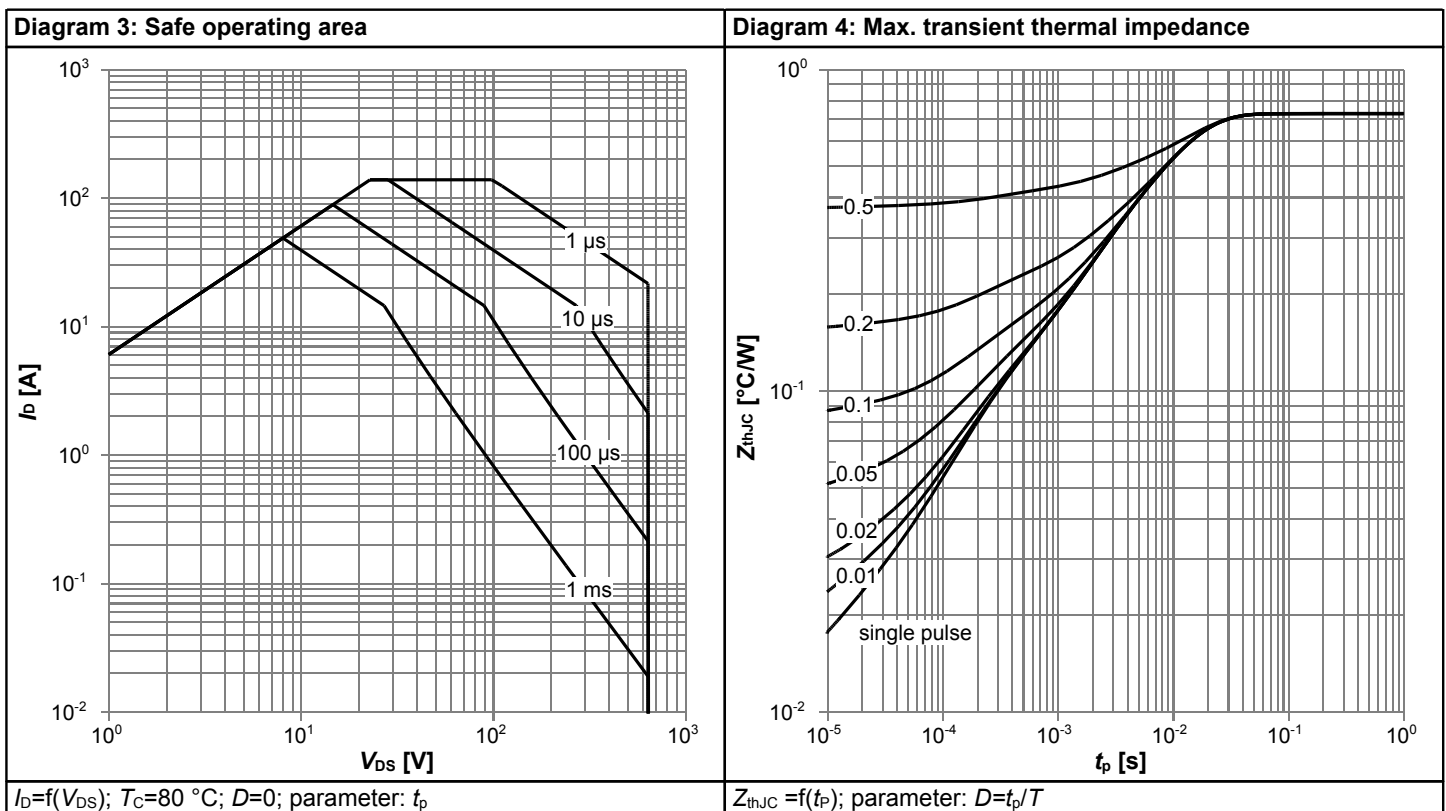
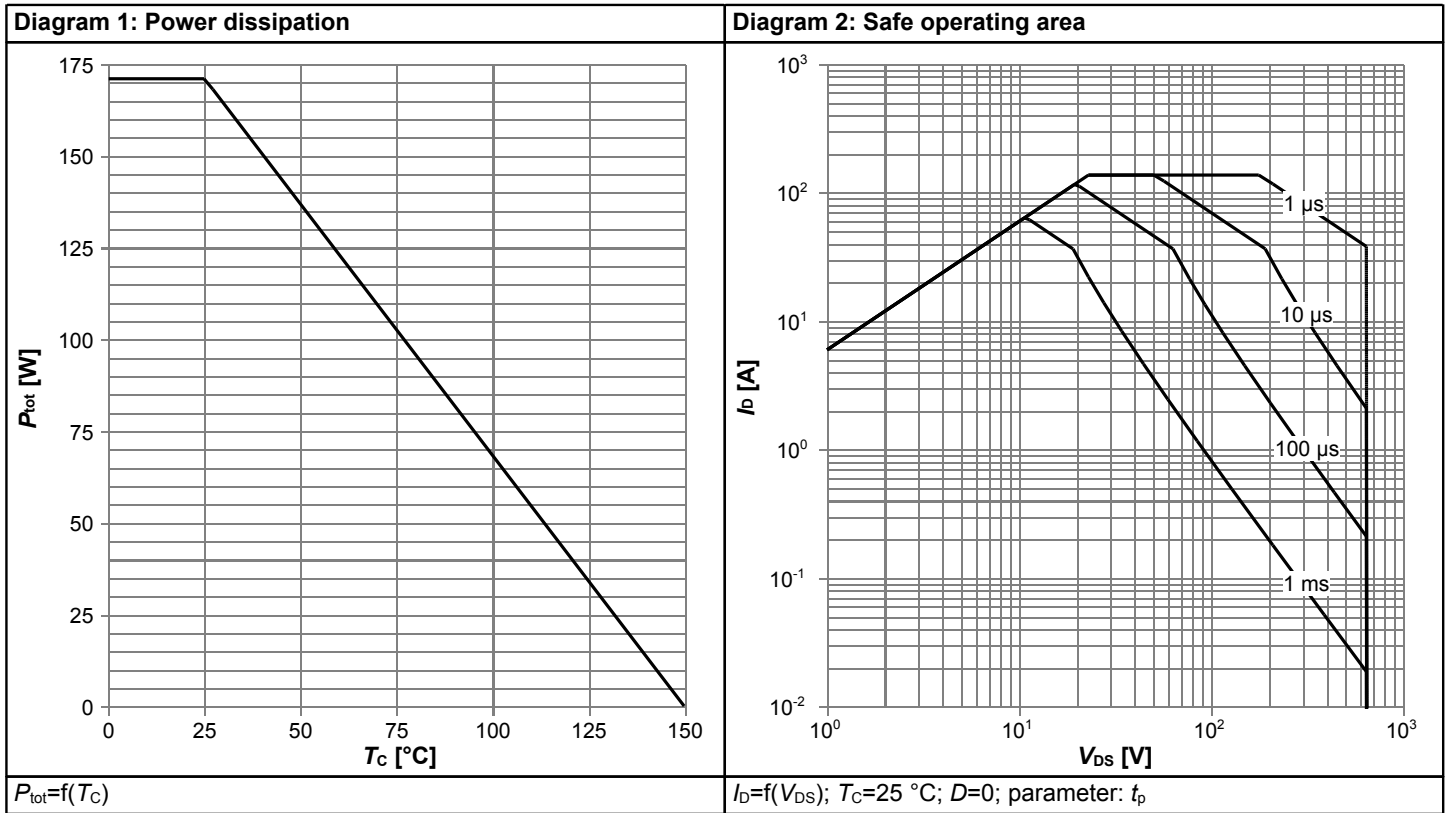
**Table 6 Gate charge characteristics**

Parameter	Symbol	Values			Unit	Note / Test Condition
		Min.	Typ.	Max.		
Gate to source charge	$Q_{gs}$	-	19	-	nC	$V_{DD}=400V, I_D=16.4A, V_{GS}=0$ to 10V
Gate to drain charge	$Q_{gd}$	-	21	-	nC	$V_{DD}=400V, I_D=16.4A, V_{GS}=0$ to 10V
Gate charge total	$Q_g$	-	68	-	nC	$V_{DD}=400V, I_D=16.4A, V_{GS}=0$ to 10V
Gate plateau voltage	$V_{plateau}$	-	5.7	-	V	$V_{DD}=400V, I_D=16.4A, V_{GS}=0$ to 10V

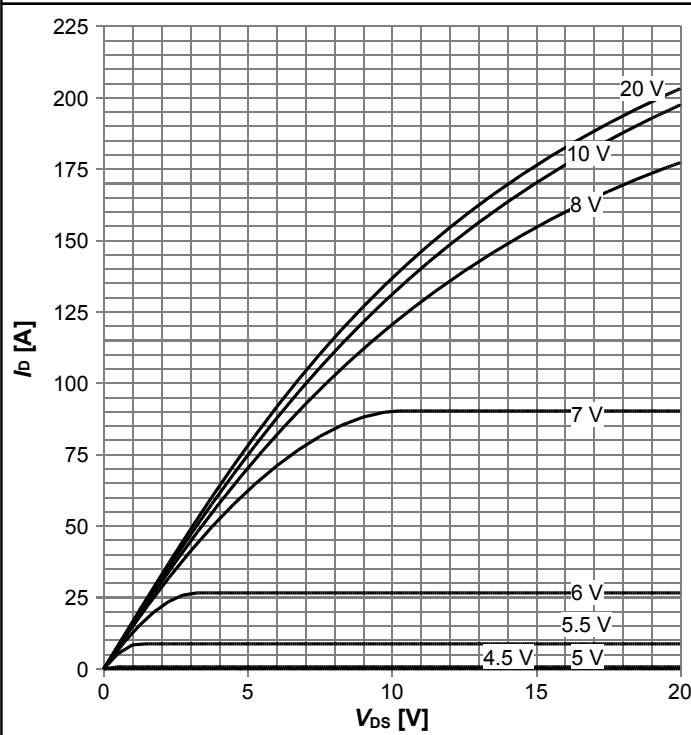
**Table 7 Reverse diode characteristics**

Parameter	Symbol	Values			Unit	Note / Test Condition
		Min.	Typ.	Max.		
Diode forward voltage	$V_{SD}$	-	1.1	-	V	$V_{GS}=0V, I_F=16.4A, T_j=25^\circ C$
Reverse recovery time	$t_{rr}$	-	156	-	ns	$V_R=400V, I_F=16.4A, di_F/dt=100A/\mu s$ ; see table 8
Reverse recovery charge	$Q_{rr}$	-	0.86	-	$\mu C$	$V_R=400V, I_F=16.4A, di_F/dt=100A/\mu s$ ; see table 8
Peak reverse recovery current	$I_{rrm}$	-	10.1	-	A	$V_R=400V, I_F=16.4A, di_F/dt=100A/\mu s$ ; see table 8

### 4 Electrical characteristics diagrams

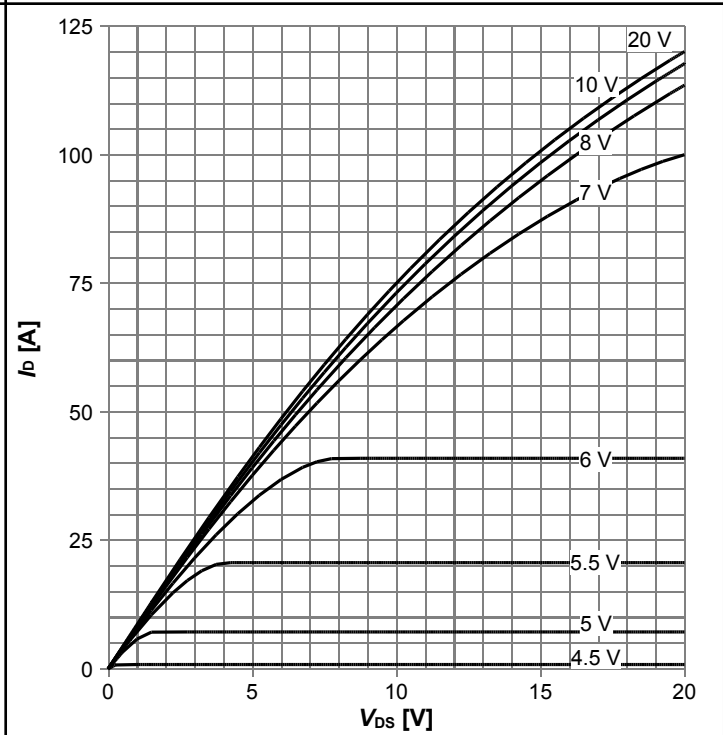


**Diagram 5: Typ. output characteristics**



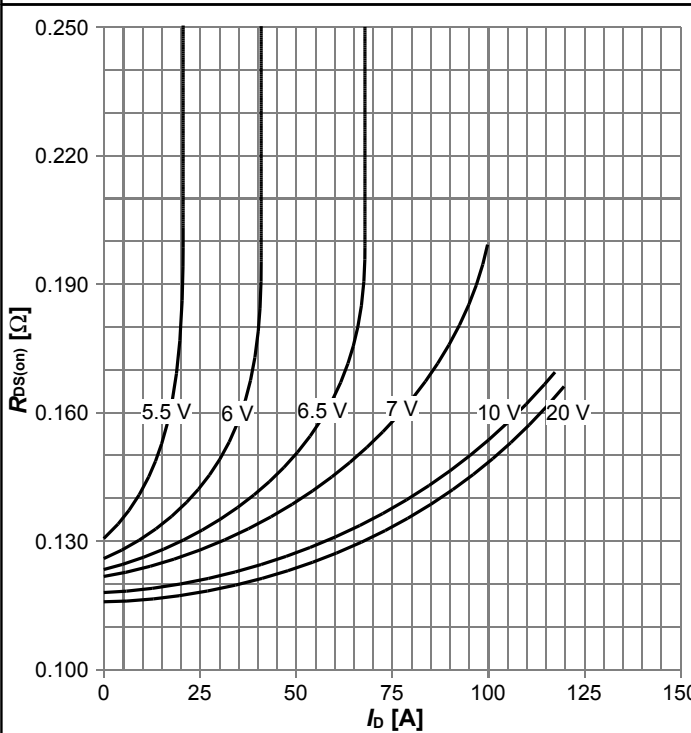
$I_D=f(V_{DS}); T_j=25\text{ °C}; \text{parameter: } V_{GS}$

**Diagram 6: Typ. output characteristics**



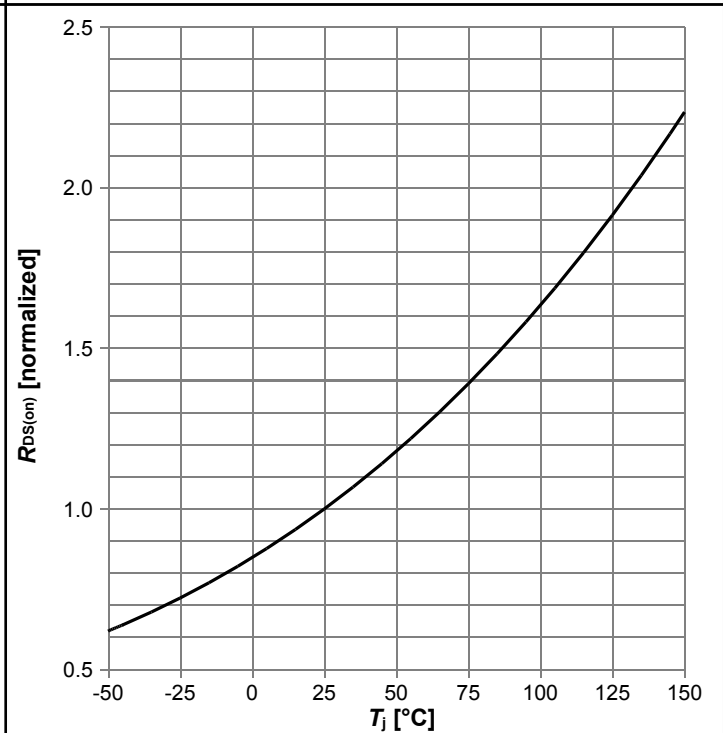
$I_D=f(V_{DS}); T_j=125\text{ °C}; \text{parameter: } V_{GS}$

**Diagram 7: Typ. drain-source on-state resistance**



$R_{DS(on)}=f(I_D); T_j=125\text{ °C}; \text{parameter: } V_{GS}$

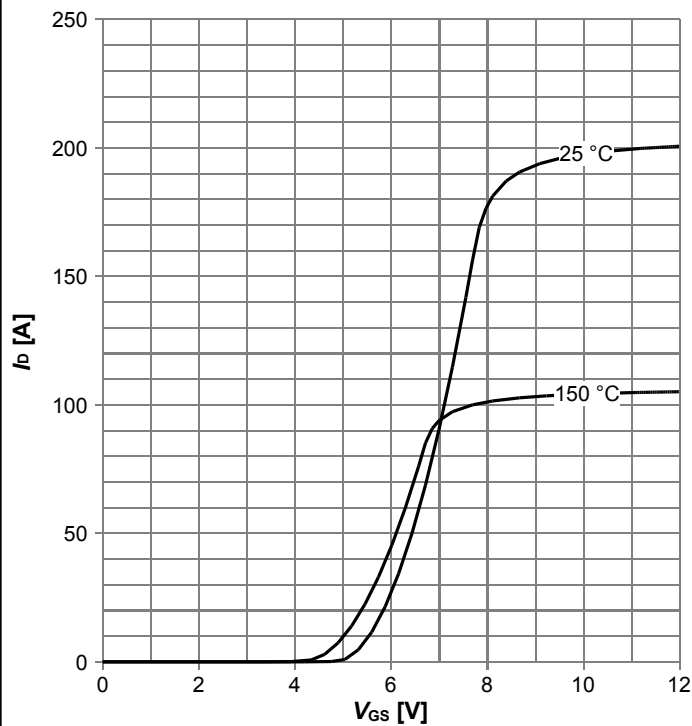
**Diagram 8: Drain-source on-state resistance**



$R_{DS(on)}=f(T_j); I_D=16.4\text{ A}; V_{GS}=10\text{ V}$

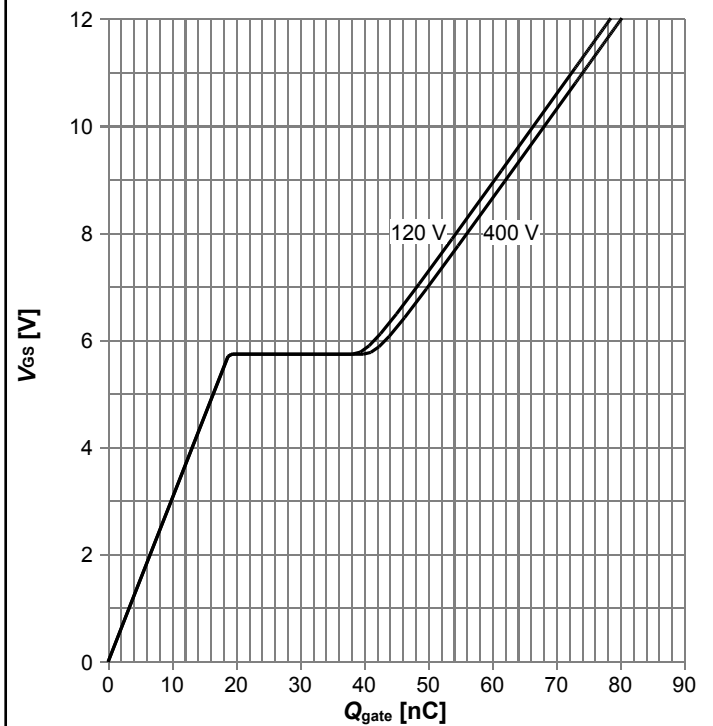


Diagram 9: Typ. transfer characteristics



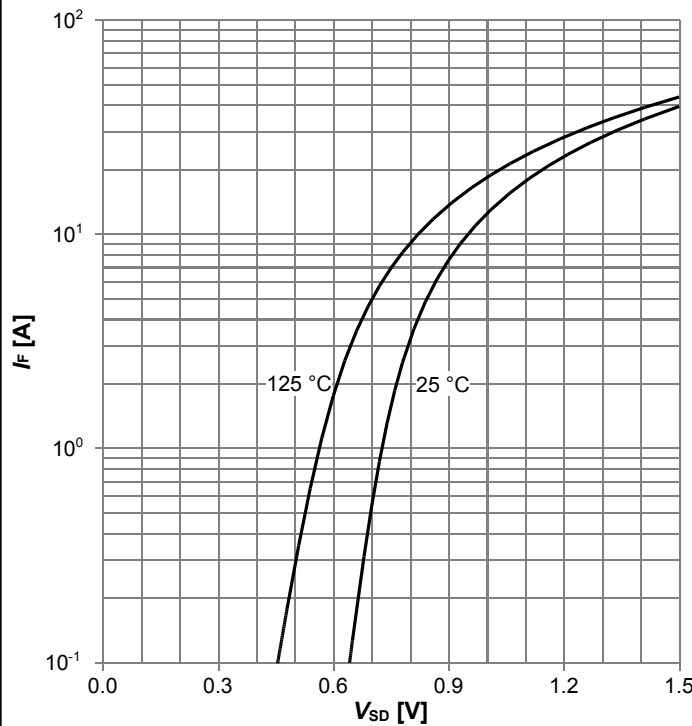
$I_D = f(V_{GS})$ ;  $V_{DS} = 20V$ ; parameter:  $T_j$

Diagram 10: Typ. gate charge



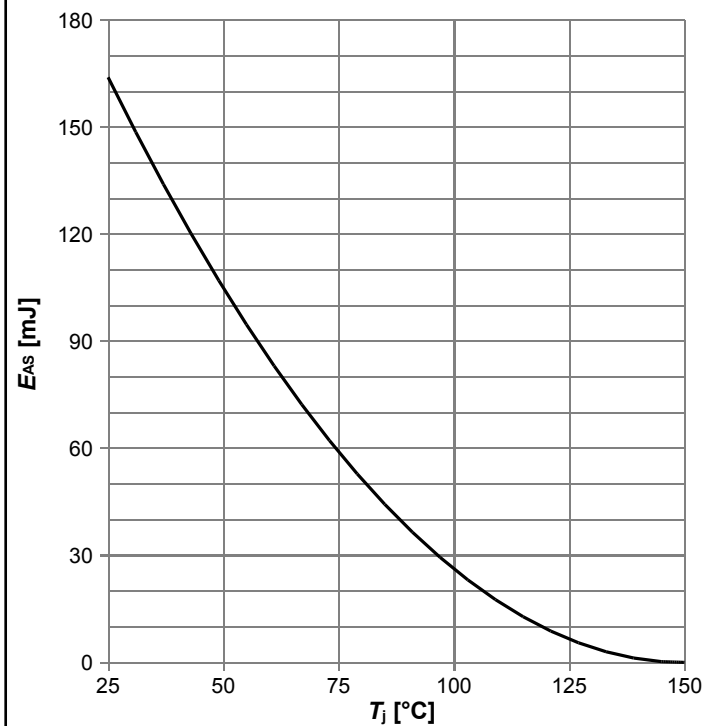
$V_{GS} = f(Q_{gate})$ ;  $I_D = 16.4 A$  pulsed; parameter:  $V_{DD}$

Diagram 11: Forward characteristics of reverse diode



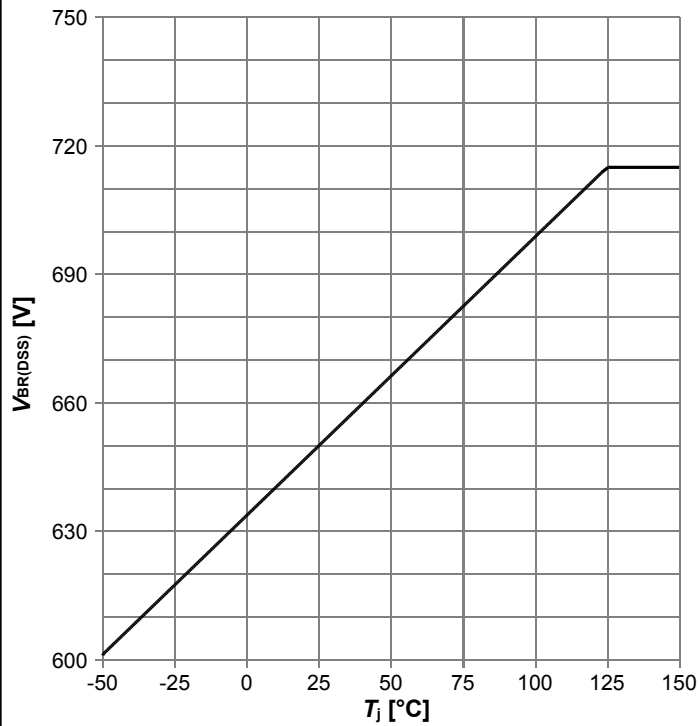
$I_F = f(V_{SD})$ ; parameter:  $T_j$

Diagram 12: Avalanche energy



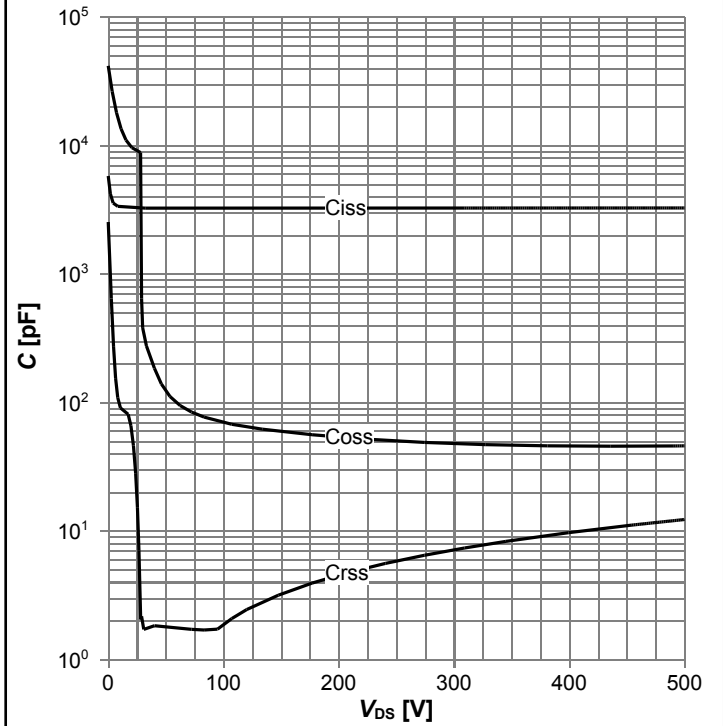
$E_{AS} = f(T_j)$ ;  $I_D = 5.1 A$ ;  $V_{DD} = 50 V$

**Diagram 13: Drain-source breakdown voltage**



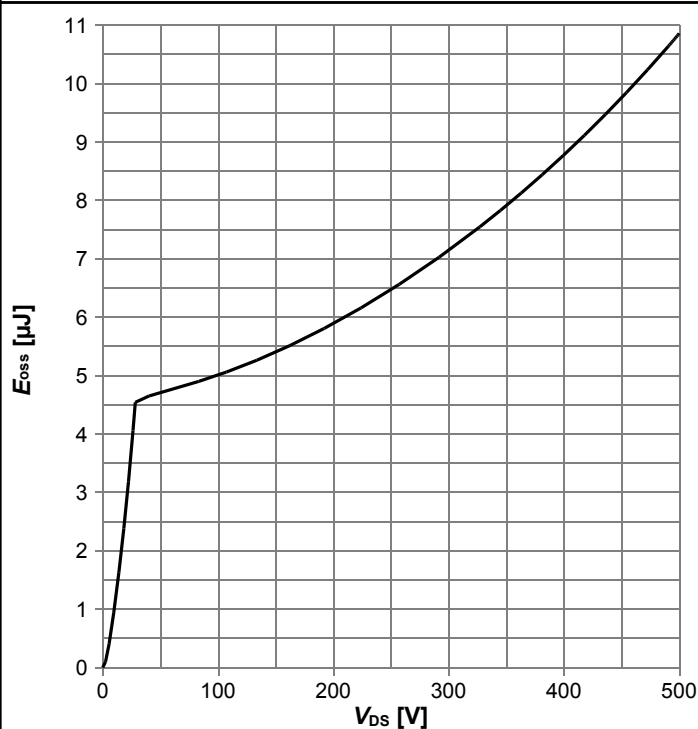
$V_{BR(DSS)}=f(T_j); I_D=1 \text{ mA}$

**Diagram 14: Typ. capacitances**



$C=f(V_{DS}); V_{GS}=0 \text{ V}; f=250 \text{ kHz}$

**Diagram 15: Typ. Coss stored energy**



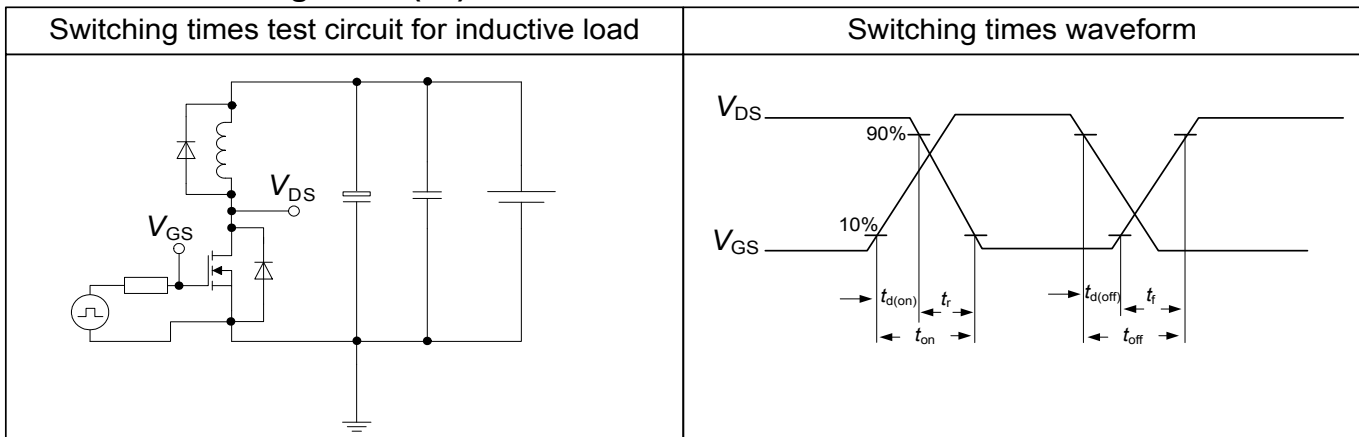
$E_{oss}=f(V_{DS})$

## 5 Test Circuits

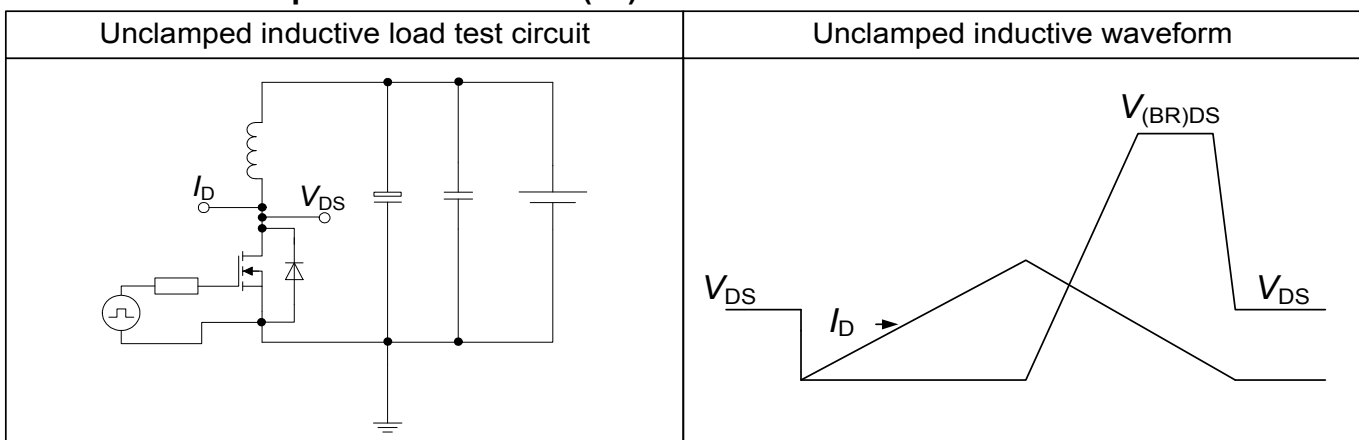
**Table 8 Diode characteristics**



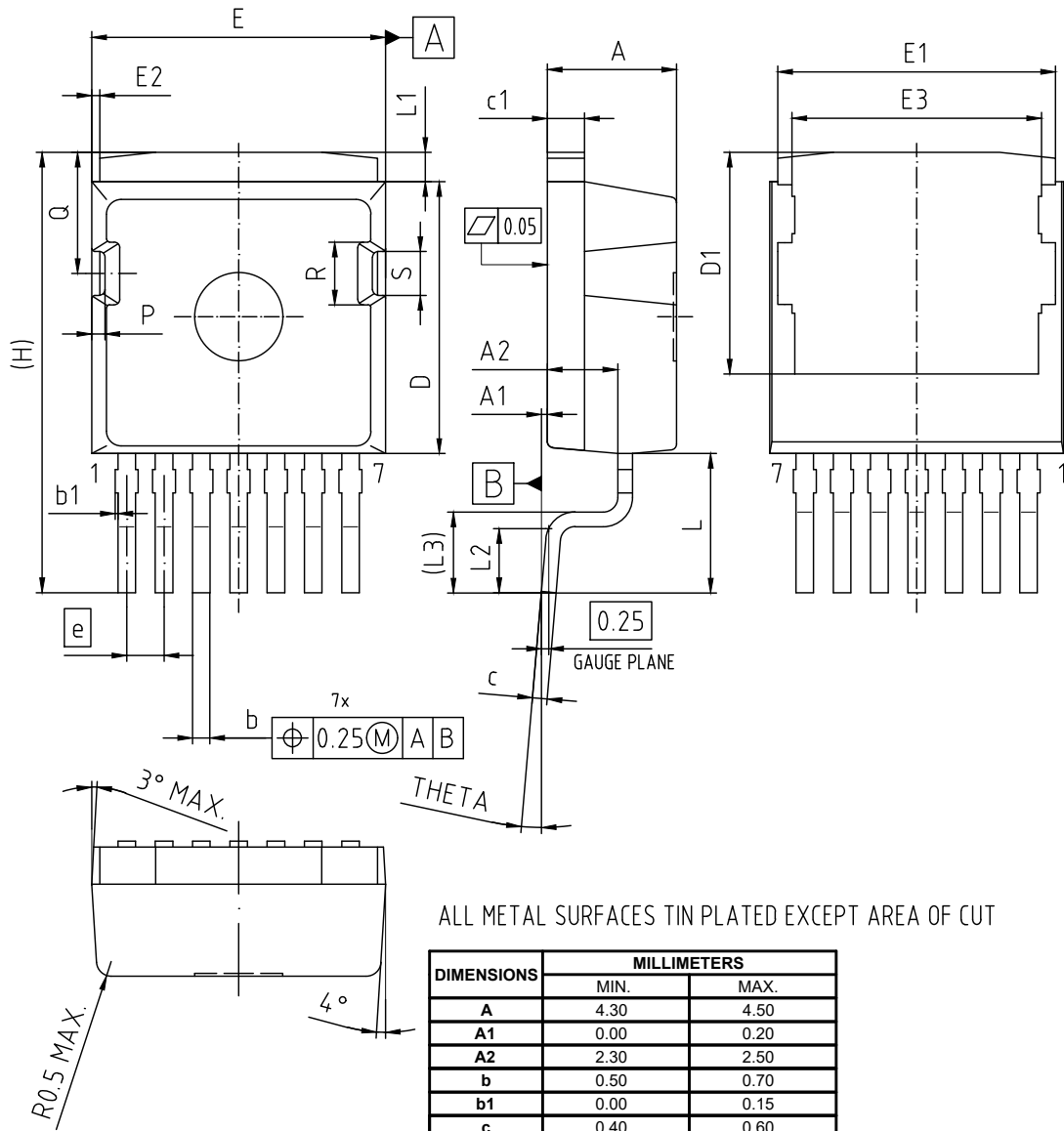
**Table 9 Switching times (ss)**



**Table 10 Unclamped inductive load (ss)**



**6 Package Outlines**



ALL METAL SURFACES TIN PLATED EXCEPT AREA OF CUT

DIMENSIONS	MILLIMETERS	
	MIN.	MAX.
A	4.30	4.50
A1	0.00	0.20
A2	2.30	2.50
b	0.50	0.70
b1	0.00	0.15
c	0.40	0.60
c1	1.17	1.37
D	9.05	9.45
D1	7.30	7.50
E	9.80	10.20
E1	9.36	9.56
E2	0.00	0.30
E3	8.40	8.60
e	1.27	
H	15.00	
L	4.20	5.20
L1	0.70	1.30
L2	1.70	2.30
L3	2.70	
P	0.35	0.55
Q	4.02	4.22
R	2.03	2.23
S	1.40	1.60
THETA	0.00°	8.00°

<b>DOCUMENT NO.</b> Z8B00189665
<b>REVISION</b> 01
<b>SCALE 5:1</b> 0 1 2 3 4 5mm
<b>EUROPEAN PROJECTION</b> 
<b>ISSUE DATE</b> 20.09.2018

**Figure 1 Outline PG-T0263-7-11, dimensions in mm**

## 7 Appendix A

### Table 11 Related Links

- IFX CoolMOS CFD7A Webpage: [www.infineon.com](http://www.infineon.com)
- IFX CoolMOS CFD7A application note: [www.infineon.com](http://www.infineon.com)
- IFX CoolMOS CFD7A simulation model: [www.infineon.com](http://www.infineon.com)
- IFX Design tools: [www.infineon.com](http://www.infineon.com)

## Revision History

IPBE65R075CFD7A

**Revision: 2021-11-24, Rev. 2.2**

Previous Revision

Revision	Date	Subjects (major changes since last revision)
2.0	2020-03-04	Release of final version
2.1	2020-04-02	Updated marketing text and drain-source breakdown voltage footnote.
2.2	2021-11-24	Change of wording regarding breakdown voltage / cosmic ray

### Trademarks

All referenced product or service names and trademarks are the property of their respective owners.

### Disclaimer

#### We Listen to Your Comments

Any information within this document that you feel is wrong, unclear or missing at all? Your feedback will help us to continuously improve the quality of this document. Please send your proposal (including a reference to this document) to:

[erratum@infineon.com](mailto:erratum@infineon.com)

#### Published by

**Infineon Technologies AG**

**81726 München, Germany**

**© 2021 Infineon Technologies AG**

**All Rights Reserved.**

#### Legal Disclaimer

The information given in this document shall in no event be regarded as a guarantee of conditions or characteristics ("Beschaffheitsgarantie").

With respect to any examples, hints or any typical values stated herein and/or any information regarding the application of the product, Infineon Technologies hereby disclaims any and all warranties and liabilities of any kind, including without limitation warranties of non-infringement of intellectual property rights of any third party.

In addition, any information given in this document is subject to customer's compliance with its obligations stated in this document and any applicable legal requirements, norms and standards concerning customer's products and any use of the product of Infineon Technologies in customer's applications.

The data contained in this document is exclusively intended for technically trained staff. It is the responsibility of customer's technical departments to evaluate the suitability of the product for the intended application and the completeness of the product information given in this document with respect to such application.

#### Information

For further information on technology, delivery terms and conditions and prices please contact your nearest Infineon Technologies Office ([www.infineon.com](http://www.infineon.com)).

#### Warnings

Due to technical requirements components may contain dangerous substances. For information on the types in question please contact your nearest Infineon Technologies Office.

Infineon Technologies Components may only be used in life-support devices or systems with the express written approval of Infineon Technologies, if a failure of such components can reasonably be expected to cause the failure of that life-support device or system, or to affect the safety or effectiveness of that device or system. Life support devices or systems are intended to be implanted in the human body, or to support and/or maintain and sustain and/or protect human life.

If they fail, it is reasonable to assume that the health of the user or other persons may be endangered.