

OptiMOS™ -T2 Power-Transistor

Features

- N-channel - Enhancement mode
- AEC Q101 qualified
- MSL1 up to 260°C peak reflow
- 175°C operating temperature
- RoHS compliant
- 100% Avalanche tested
- Ultra low $R_{DS(on)}$
- Ultra high I_D

Product Summary

V_{DS}	80	V
$R_{DS(on),max}$	2.2	mΩ
I_D	180	A

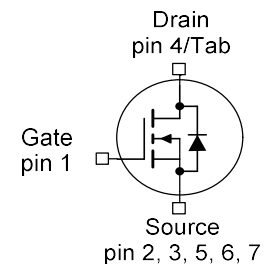
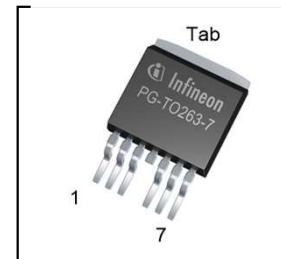
PG-TO263-7-3

Type	Package	Marking
IPB180N08S4-02	PG-TO263-7-3	4N0802

Maximum ratings, at $T_j=25^\circ\text{C}$, unless otherwise specified

Parameter	Symbol	Conditions	Value	Unit
Continuous drain current ¹⁾	I_D	$T_C=25^\circ\text{C}$, $V_{GS}=10\text{V}$	180	A
		$T_C=100^\circ\text{C}$, $V_{GS}=10\text{V}^{2)}$	180	
Pulsed drain current ²⁾	$I_{D,pulse}$	$T_C=25^\circ\text{C}$	720	
Avalanche energy, single pulse ²⁾	E_{AS}	$I_D=90\text{A}$	640	mJ
Avalanche current, single pulse	I_{AS}	-	175	A
Gate source voltage	V_{GS}	-	± 20	V
Power dissipation	P_{tot}	$T_C=25^\circ\text{C}$	277	W
Operating and storage temperature	T_j, T_{stg}	-	-55 ... +175	$^\circ\text{C}$

Parameter	Symbol	Conditions	Values			Unit
			min.	typ.	max.	

Thermal characteristics²⁾

Thermal resistance, junction - case	R_{thJC}	-	-	-	0.54	K/W
SMD version, device on PCB	R_{thJA}	minimal footprint	-	-	62	
		6 cm ² cooling area ³⁾	-	-	40	

Electrical characteristics, at $T_j=25\text{ °C}$, unless otherwise specified
Static characteristics

Drain-source breakdown voltage	$V_{(BR)DSS}$	$V_{GS}=0V, I_D=1mA$	80	-	-	V
Gate threshold voltage	$V_{GS(th)}$	$V_{DS}=V_{GS}, I_D=220\mu A$	2.0	3.0	4.0	
Zero gate voltage drain current	I_{DSS}	$V_{DS}=80V, V_{GS}=0V, T_j=25\text{ °C}$	-	0.03	1	μA
		$V_{DS}=80V, V_{GS}=0V, T_j=125\text{ °C}^{2)}$	-	10	200	
Gate-source leakage current	I_{GSS}	$V_{GS}=20V, V_{DS}=0V$	-	-	100	nA
Drain-source on-state resistance	$R_{DS(on)}$	$V_{GS}=10V, I_D=100A$	-	1.8	2.2	m Ω

Parameter	Symbol	Conditions	Values			Unit
			min.	typ.	max.	

Dynamic characteristics²⁾

Input capacitance	C_{iss}	$V_{GS}=0V, V_{DS}=25V,$ $f=1MHz$	-	8884	11550	pF
Output capacitance	C_{oss}		-	3435	4465	
Reverse transfer capacitance	C_{rss}		-	177	354	
Turn-on delay time	$t_{d(on)}$	$V_{DD}=40V, V_{GS}=10V,$ $I_D=180A, R_G=3.5\Omega$	-	30	-	ns
Rise time	t_r		-	15	-	
Turn-off delay time	$t_{d(off)}$		-	50	-	
Fall time	t_f		-	50	-	

Gate Charge Characteristics²⁾

Gate to source charge	Q_{gs}	$V_{DD}=64V, I_D=180A,$ $V_{GS}=0 \text{ to } 10V$	-	45	58	nC
Gate to drain charge	Q_{gd}		-	27	55	
Gate charge total	Q_g		-	128	167	
Gate plateau voltage	$V_{plateau}$		-	5.1	-	V

Reverse Diode

Diode continuous forward current ²⁾	I_S	$T_C=25^\circ C$	-	-	180	A
Diode pulse current ²⁾	$I_{S,pulse}$		-	-	720	
Diode forward voltage	V_{SD}	$V_{GS}=0V, I_F=100A,$ $T_j=25^\circ C$	-	1	1.2	V
Reverse recovery time ²⁾	t_{rr}	$V_R=40V, I_F=50A,$ $di_F/dt=100A/\mu s$	-	80	-	ns
Reverse recovery charge ²⁾	Q_{rr}		-	160	-	nC

¹⁾ Current is limited by bondwire; with an $R_{thJC} = 0.54K/W$ the chip is able to carry 237A at 25°C.

²⁾ Specified by design. Not subject to production test.

³⁾ Device on 40 mm x 40 mm x 1.5 mm epoxy PCB FR4 with 6 cm² (one layer, 70 μm thick) copper area for drain connection. PCB is vertical in still air.

1 Power dissipation

$P_{tot} = f(T_C); V_{GS} \geq 6\text{ V}$

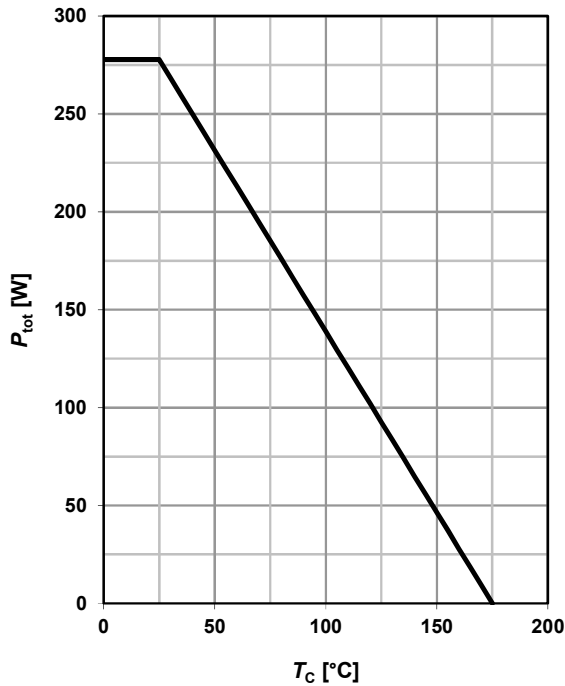

2 Drain current

$I_D = f(T_C); V_{GS} \geq 6\text{ V}; \text{SMD}$

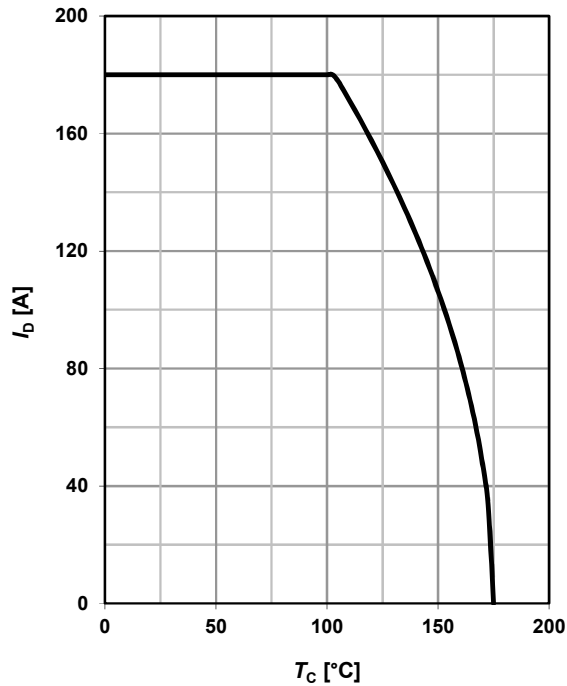

3 Safe operating area

$I_D = f(V_{DS}); T_C = 25\text{ °C}; D = 0; \text{SMD}$

parameter: t_p

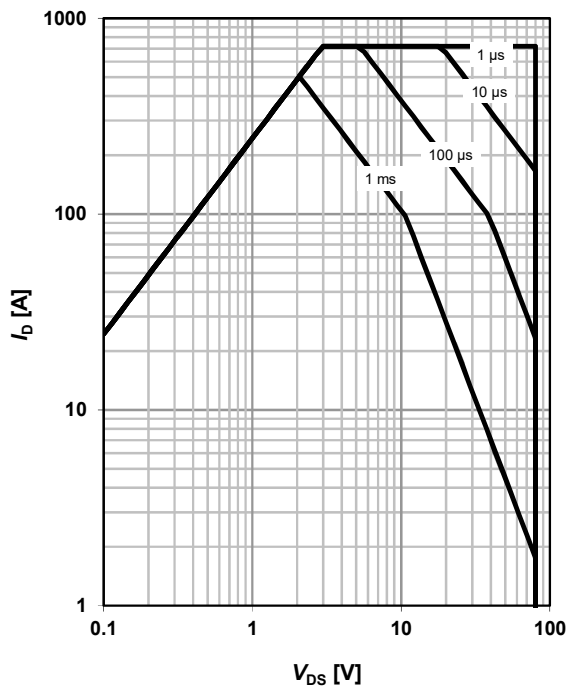

4 Max. transient thermal impedance

$Z_{thJC} = f(t_p)$

parameter: $D = t_p/T$

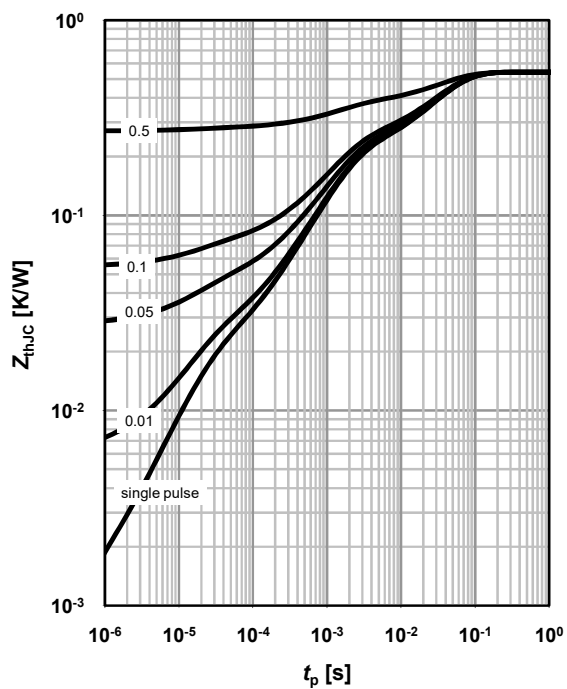

5 Typ. output characteristics

$I_D = f(V_{DS}); T_j = 25\text{ °C}; \text{SMD}$

parameter: V_{GS}

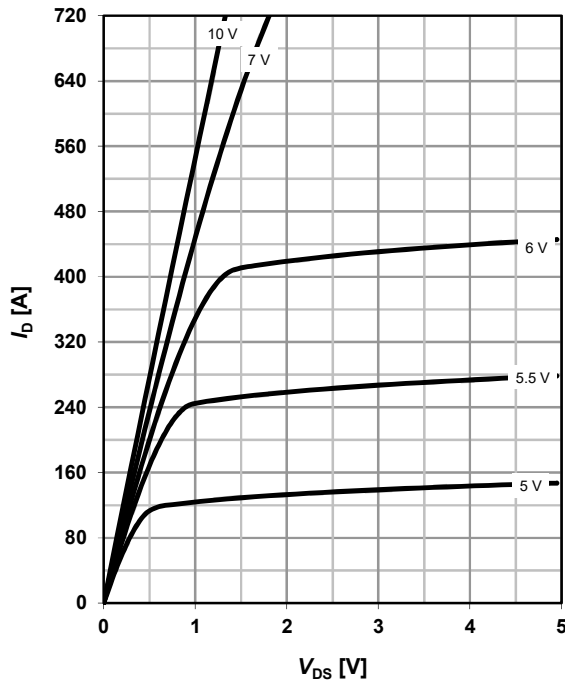

6 Typ. drain-source on-state resistance

$R_{DS(on)} = f(I_D); T_j = 25\text{ °C}; \text{SMD}$

parameter: V_{GS}

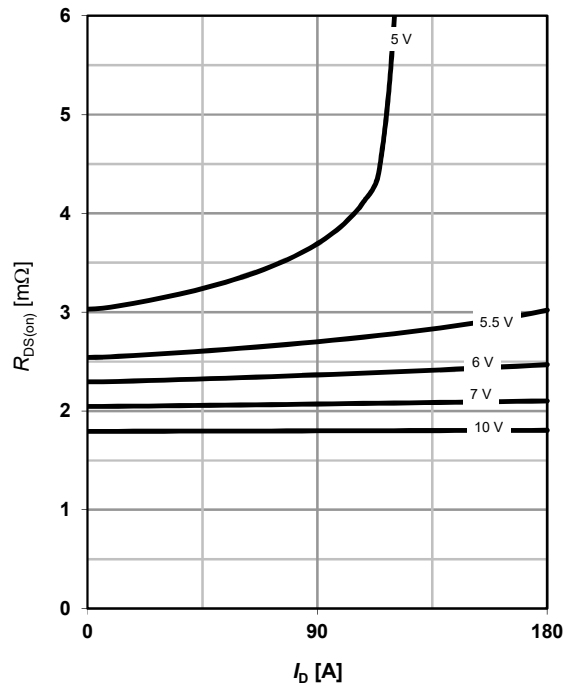

7 Typ. transfer characteristics

$I_D = f(V_{GS}); V_{DS} = 6\text{ V}$

parameter: T_j

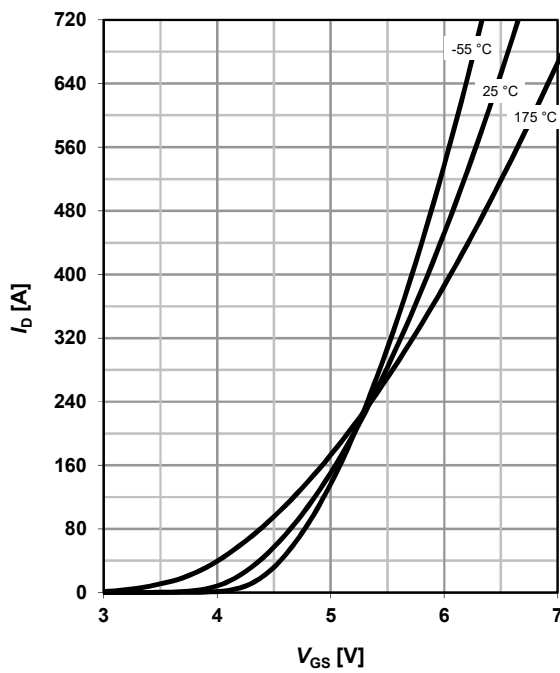

8 Typ. drain-source on-state resistance

$R_{DS(on)} = f(T_j); I_D = 100\text{ A}; V_{GS} = 10\text{ V}; \text{SMD}$

$\alpha = 0.4$

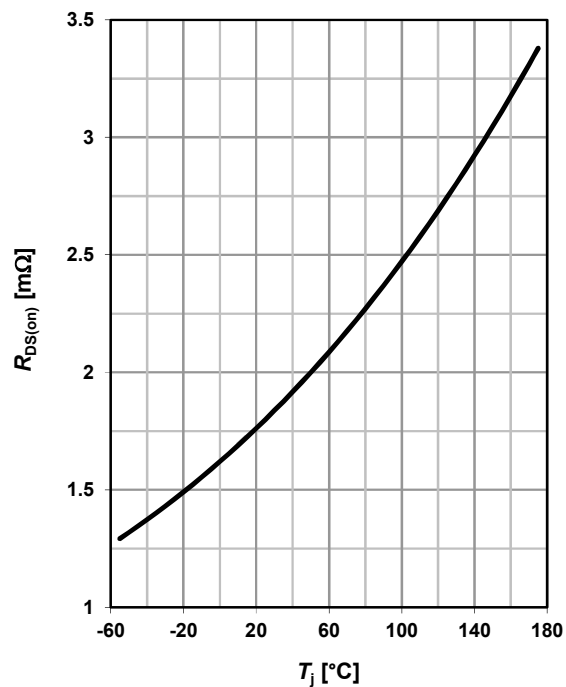

9 Typ. gate threshold voltage

$$V_{GS(th)} = f(T_j); V_{GS} = V_{DS}$$

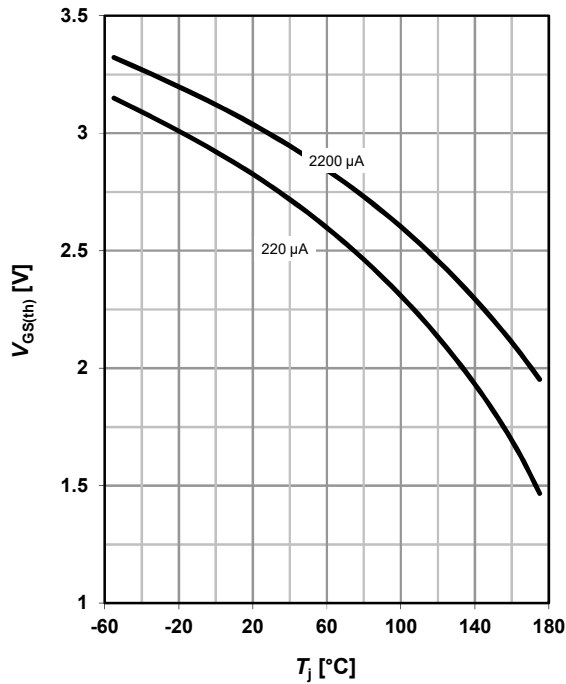
 parameter: I_D

10 Typ. capacitances

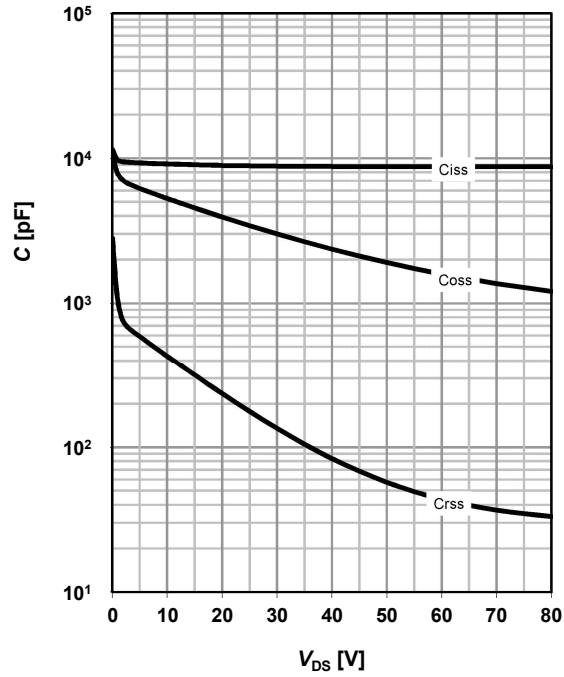
$$C = f(V_{DS}); V_{GS} = 0 V; f = 1 \text{ MHz}$$

11 Typical forward diode characteristics

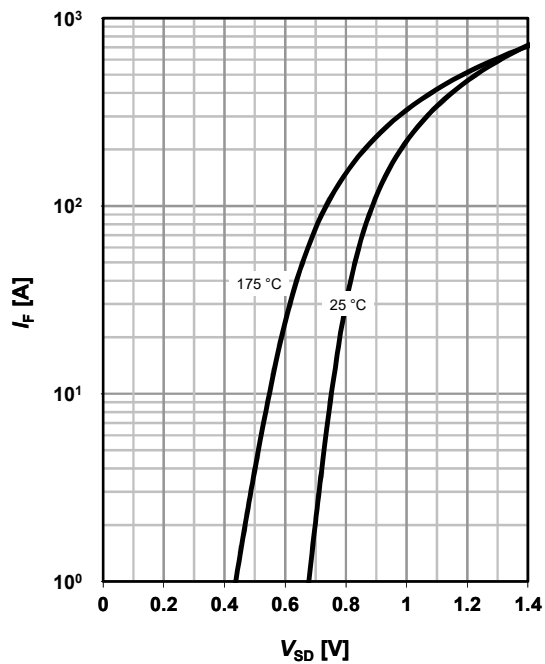
$$I_F = f(V_{SD})$$

 parameter: T_j

12 Avalanche characteristics

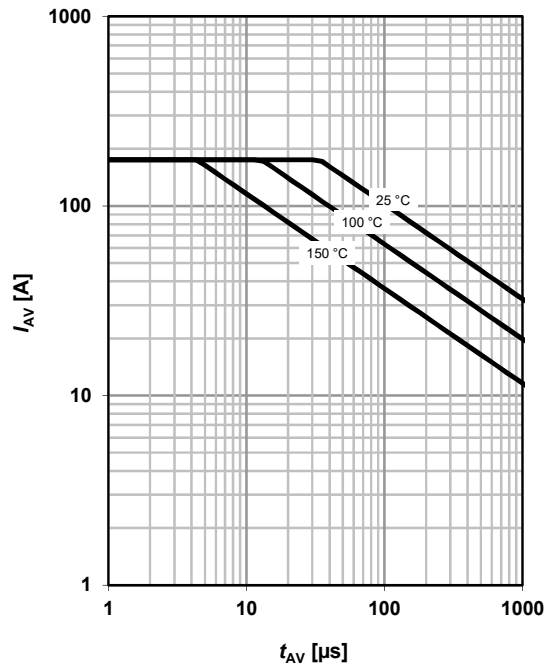
$$I_{AS} = f(t_{AV})$$

 parameter: $T_{j(start)}$

13 Avalanche energy

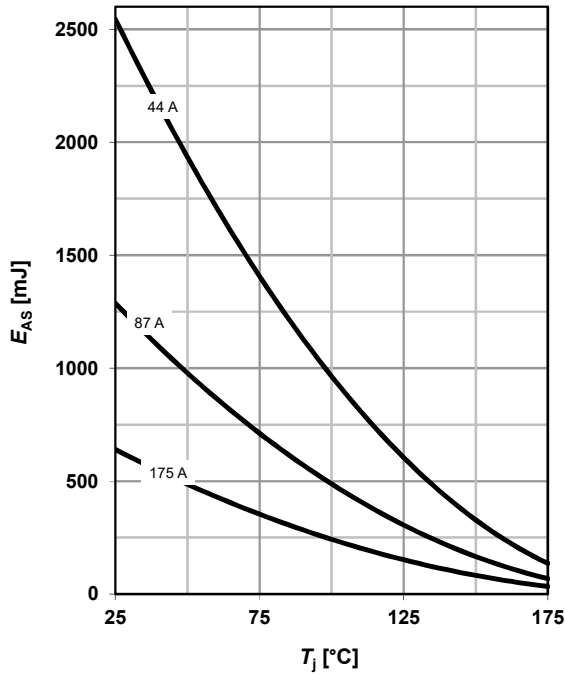
$E_{AS} = f(T_j); I_D = 90 \text{ A}$



14 Drain-source breakdown voltage

$V_{BR(DSS)} = f(T_j); I_D = 1 \text{ mA}$

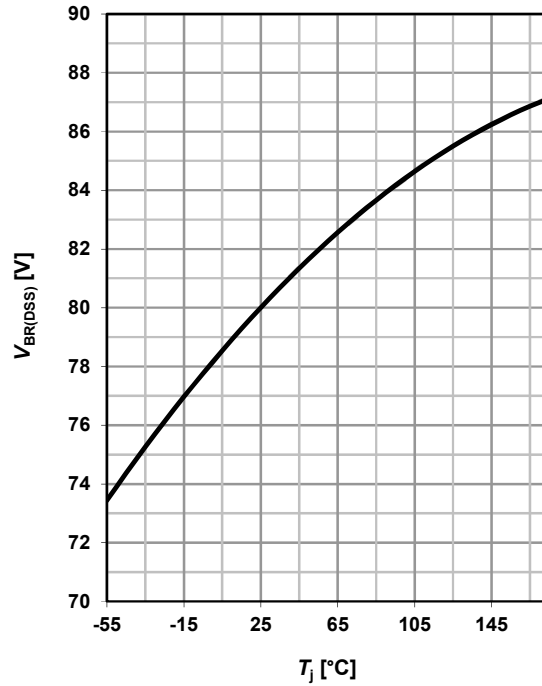

15 Typ. gate charge

$V_{GS} = f(Q_{gate}); I_D = 180 \text{ A pulsed}$
parameter: V_{DD}

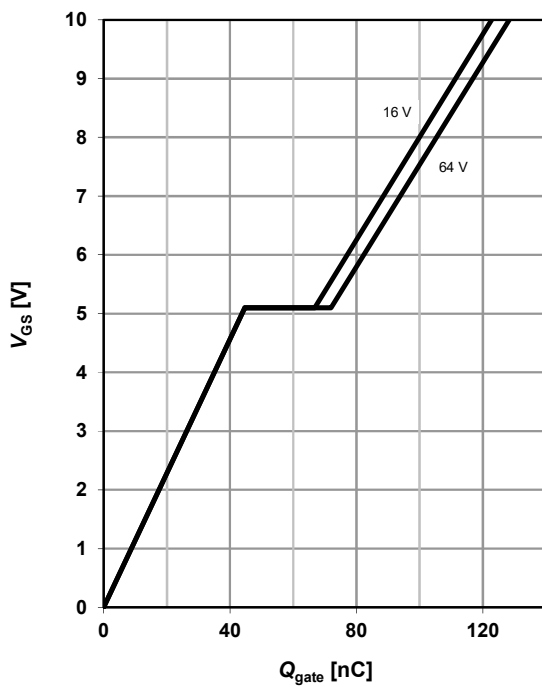

16 Gate charge waveforms

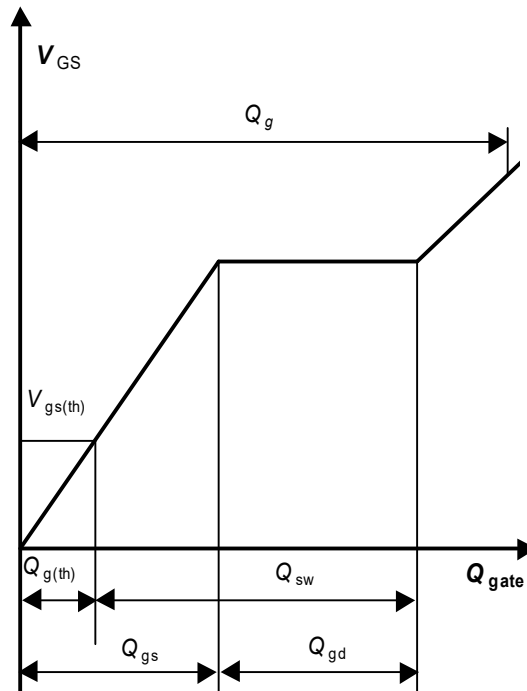

Package Outline

P-TO263-3-2: Outline

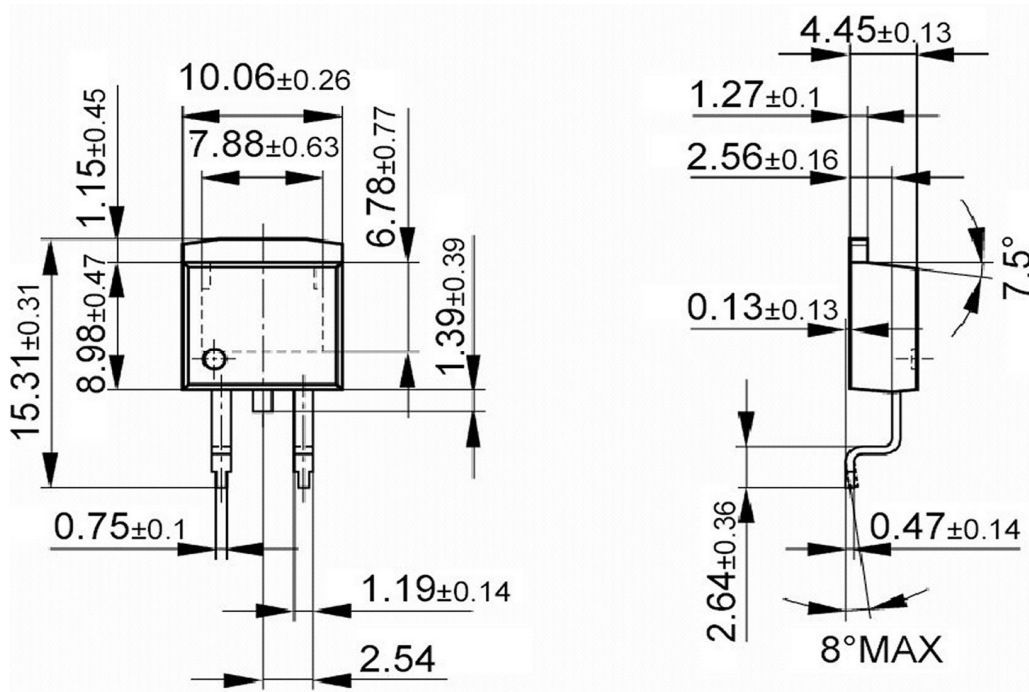

Footprint

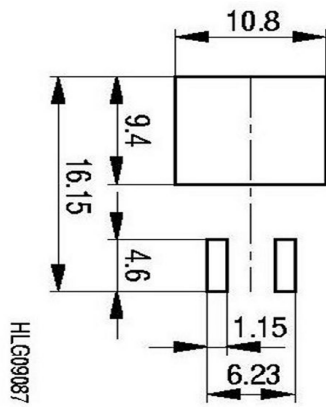

Packaging

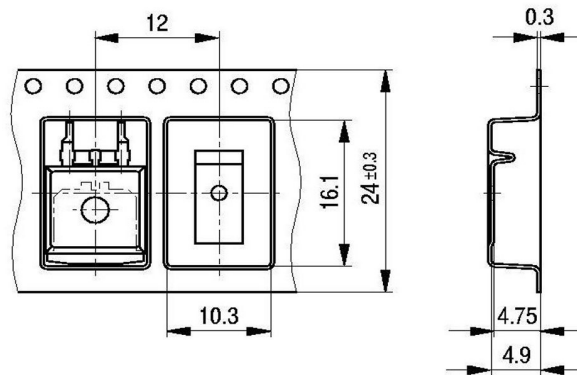

P-TO262-3-1: Outline

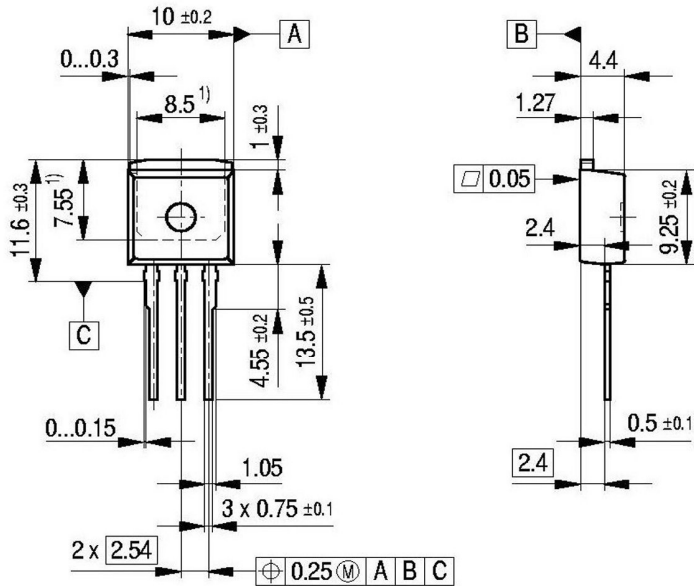

1) Typical
 Metal surface min. X = 7.25, Y = 6.9
 All metal surfaces tin plated, except area of cut.

P-TO220-3-1: Outline

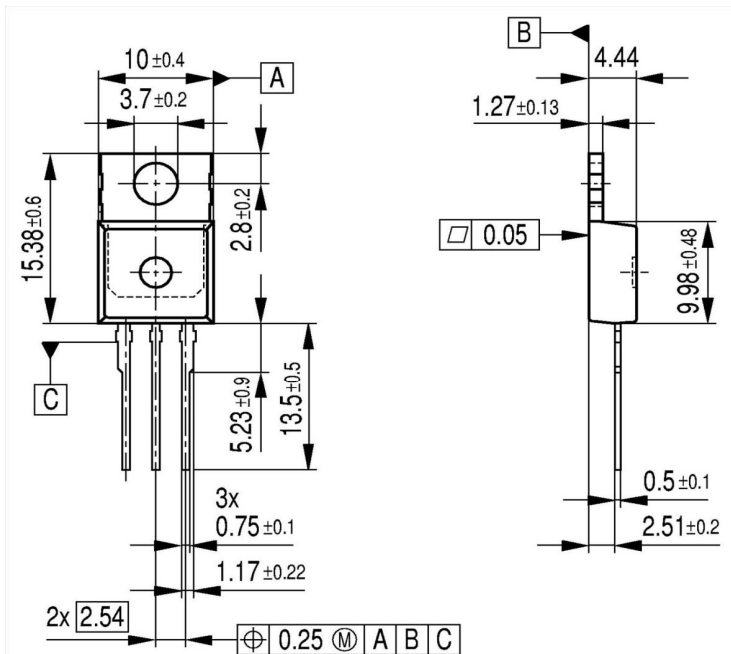

All metal surfaces tin plated, except area of cut.
 Metal surface min. x=7.25, y=12.3

Packaging

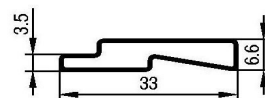

Dimensions in mm

Trademarks

All referenced product or service names and trademarks are the property of their respective owners.

Edition 2022-08-24**Published by****Infineon Technologies AG****81726 Munich, Germany****© 2022 Infineon Technologies AG****All Rights Reserved.****Do you have any questions about any aspect of this document?****Email: erratum@infineon.com****Document reference****IPB180N08S4-02-Data-Sheet-11-Infineon****IMPORTANT NOTICE**

The information given in this document shall in no event be regarded as a guarantee of conditions or characteristics ("Beschaffenheitsgarantie").

With respect to any examples, hints or any typical values stated herein and/or any information regarding the application of the product, Infineon Technologies hereby disclaims any and all warranties and liabilities of any kind, including without limitation warranties of non-infringement of intellectual property rights of any third party.

In addition, any information given in this document is subject to customer's compliance with its obligations stated in this document and any applicable legal requirements, norms and standards concerning customer's products and any use of the product of Infineon Technologies in customer's applications. The data contained in this document is exclusively intended for technically trained staff. It is the responsibility of customer's technical departments to evaluate the suitability of the product for the intended application and the completeness of the product information given in this document with respect to such application.

For further information on technology, delivery terms and conditions and prices, please contact the nearest Infineon Technologies Office (www.infineon.com).

WARNINGS

Due to technical requirements products may contain dangerous substances. For information on the types in question please contact the nearest Infineon Technologies Office.

Except as otherwise explicitly approved by Infineon Technologies in a written document signed by authorized representatives of Infineon Technologies, Infineon Technologies' products may not be used in any applications where a failure of the product or any consequences of the use thereof can reasonably be expected to result in personal injury.

Revision History

Version	Date	Changes
Revision 1.0	2014-06-20	Final data sheet
Revision 1.1	2022-08-24	Diagram 8 Typ. drain-source on-state resistance: used α value clarified