

65 W Off-Line Adapter Featuring Very Low No-Load Power Consumption Evaluation Board User's Manual



ON Semiconductor®

<http://onsemi.com>

EVAL BOARD USER'S MANUAL

Overview

When designing an offline Ac-Dc power adapter, one key consideration is the power consumption in standby mode. Standby power consumption, also sometimes referred to as vampire power or phantom load, is the power consumed by electronic devices when they are switched off, but still plugged into the wall. It is estimated that standby power accounts for nearly 10% of the energy usage in the average American home. One common contributor to vampire power in the home is notebook adapters. These adapters spend a lot of time left underneath desks with the notebook computer disconnected or powered off. The following design note features the latest techniques for minimizing the standby power consumption of a 65 W notebook adapter.

When focusing on the no load power consumption of an adapter design, the key losses need to be identified. Switching losses and circuit biasing must be minimized or eliminated completely. The latest technique for minimizing losses during no load is to turn off the Ac-Dc controller and allow the output voltage to drop. Because the adapter is not supplying power, a drop in output voltage is viewed as acceptable. The following design utilizes the NCP1246 flyback controller and the NCP4354A secondary side controller to realize this technique. Both controllers have built-in features focused on minimizing no load input power consumption. Primary side flyback controller NCP1246 is a fixed frequency current mode controller featuring dynamic self supply. It also supports OFF mode and integrated active X2 capacitor discharge feature, which significantly reduces input power at very light load and no load conditions. NCP1246 includes frequency fold-back and skip mode to provide high efficiency in light load. Secondary side controller NCP4354A provides output voltage and current regulation (CCCV operation of whole SMPS), very light load condition detection, OFF mode control and indication LED driver. The NCP4354A is specially design for use in tandem with the NCP1246, detecting no load conditions and triggering OFF mode via the NCP1246 FB pin.

Key Features

- Constant Voltage Constant Current Regulation (CCCV)
- Very Low Input Power at Light and No Load
- High Efficiency Across the Entire Load Range
- Overpower Protection
- Universal Mains Operation

Circuit Description

The primary side uses a flyback topology, providing the advantage of a cost effective power stage design. The power stage operates in both CCM (continuous conduction mode) and DCM (discontinuous conduction mode), allowing it to accept a wide universal input voltage range. The CCM operation provides desired full load performance with good efficiency and low ripple of primary current. The DCM operation then permits an increase of efficiency under the light load conditions, by decreasing the switching losses. The device switches at 65 kHz which represents a good trade-off between switching losses and magnetic core size.

The adapter primary side consists of several important sections. The first is an input EMI filter to reduce the conducted EMI to the ac line at the input of the adapter. The EMI filter is formed by common-mode inductors L3 and capacitors C1, C2, C3 and C11 with differential mode inductor L2. The varistor R7 is used to protect the adapter against the line overvoltage peaks. When the power supply is disconnected from the AC mains, X capacitors C2, C13 and Y capacitors C3 and C4 are discharged through HV pin via the following path: rectifying diodes D101, D103, surge protection T network R100, R101 and C100. This feature replaces commonly used discharging resistors and saves approximately 25 mW of input power consumption at 230 Vac. The next block is the rectifier with bulk capacitor. The main power stage of the flyback converter utilizes the low R_{DSon} MOSFET SPP11N60C3 along with a custom designed transformer TR1 KA5038-BL from Coilcraft. The detailed design procedure of a flyback adapter can be found in the application note AND8461/D at ON Semiconductor website: <http://www.onsemi.com>.

NCP4354AADAPGEVB

Secondary rectification is done by a low forward voltage drop Schottky diode NTST30100SG from ON Semiconductor. A simple RC snubber across the secondary rectifier damps the high frequency ringing caused by the unclamped leakage inductance of the secondary side of the transformer and the rectification diode capacitance. Secondary controller NCP4354A provides the output voltage and output current regulation. Output voltage is set by voltage divider R112, R117, R118 and R127, output current is sensed at sense resistor R111. Regulation output

is coupled to the NCP1246 primary side controller via the optocoupler. The NCP4354 secondary controller also detects very light load condition via D105, R114, C106, R115 and R116 by OFFDET pin. When light load condition is detected, the primary controller is switched into OFF mode by ON/OFF current sink to DRIVE pin via optocoupler. The built in LED driver indicates primary side operation (when SMPS is not in OFF mode). The LED driver switches with 1 kHz frequency and 12% duty cycle in order to optimize LED efficiency.

Table 1.

Parameter	Symbol	Value	Units
Input Voltage	V_{IN}	85 – 265	V_{AC}
Input Frequency	f_{IN}	30 – 80	Hz
Output Voltage	V_{OUT}	19	V
Nominal Output Current	I_{OUTNOM}	3.4	A
Output Current Limit	I_{OUTLIM}	3.9	A
Efficiency $I_{OUT} > 3\% I_{OUTMAX}$	η	> 84	%
Efficiency $I_{OUT} > 25\% I_{OUTMAX}$	η	> 90	%
No-Load Power Consumption $V_{IN} = 115\text{ V}/60\text{ Hz}$	P_{IN}	11	mW
No-Load Power Consumption $V_{IN} = 230\text{ V}/50\text{ Hz}$	P_{IN}	21	mW
Output Voltage Ripple $I_{OUT} = 3.5\text{ A}$	V_{OUT_PK-PK}	50	mV
Load Regulation $I_{OUT} = 50\text{ mA} - 3.5\text{ A}$	$LOAD_{REG}$	31.7	mV/A
Maximal Load Resistance to Stay in On-Mode	R_{OUTON}	4.4	$k\Omega$
Minimal Load Resistance to Activate Off-Mode	R_{OUTOFF}	5.5	$k\Omega$
Board Dimension		156 x 51 x 27	mm

NCP4354AADAPGEVB

Evaluation Board Schematic

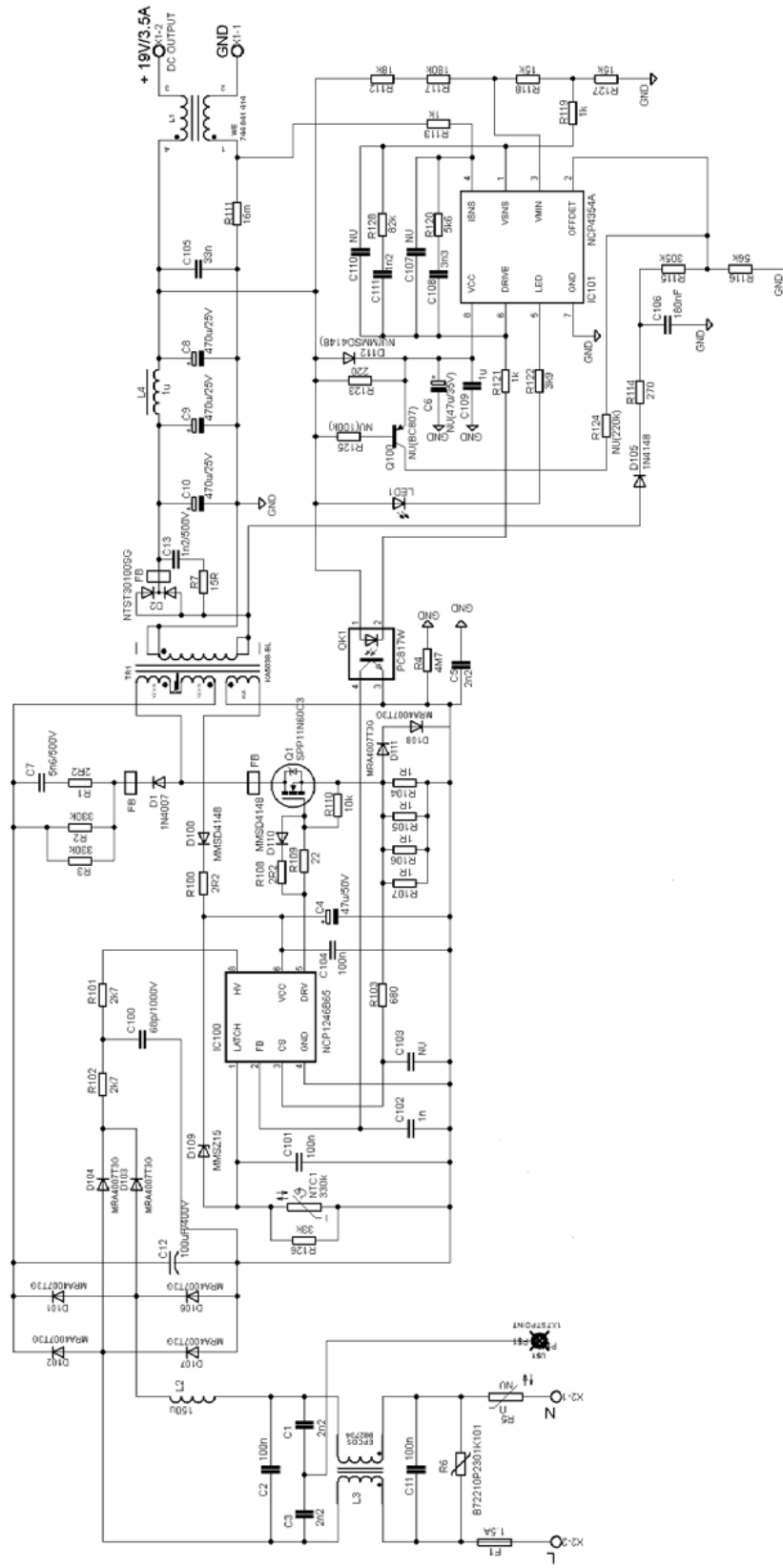

Figure 1. Evaluation Board Schematic

NCP4354AADAPGEVB

No Load Input Power Consumption

Input power consumption was measured by Yokogawa WT210 power meter. Input power was integrated for 20 minutes and averaged from 4 measurements.

Table 2.

Input Voltage [V; Hz]	Input Power [mW]
85 V; 60 Hz	9
115 V; 60 Hz	11
230 V; 50 Hz	21
265 V; 50 Hz	25

Load Regulation

The main impact on load regulation is the serial resistance of the output common mode inductor and the voltage drop on the output current sensing resistor (65.5 mV @ 3.9 A). Output voltage is sensed in front of them by resistor divider.

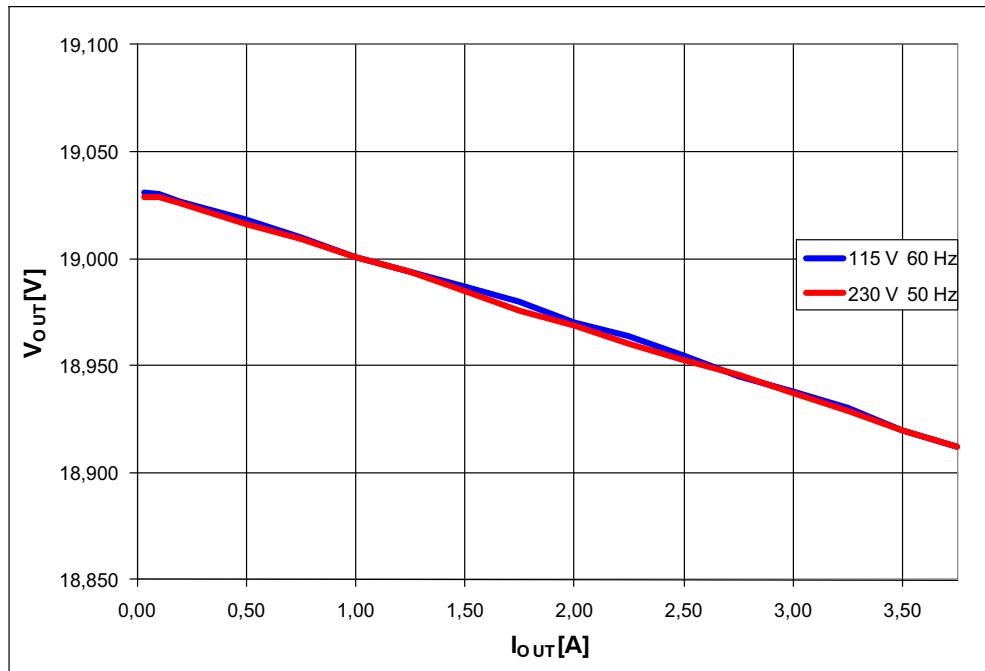

Figure 2. Load Regulation is 31.7 mV/A

Load Characteristic

The following load characteristic shows how current limitation works. When output current reaches 3.9 A, output

voltage starts to be limited to keep current at a level given by sensing resistor R111 and voltage threshold of 62.5 mV at current OTA sensing pin ISNS.

NCP4354AADAPGEVB

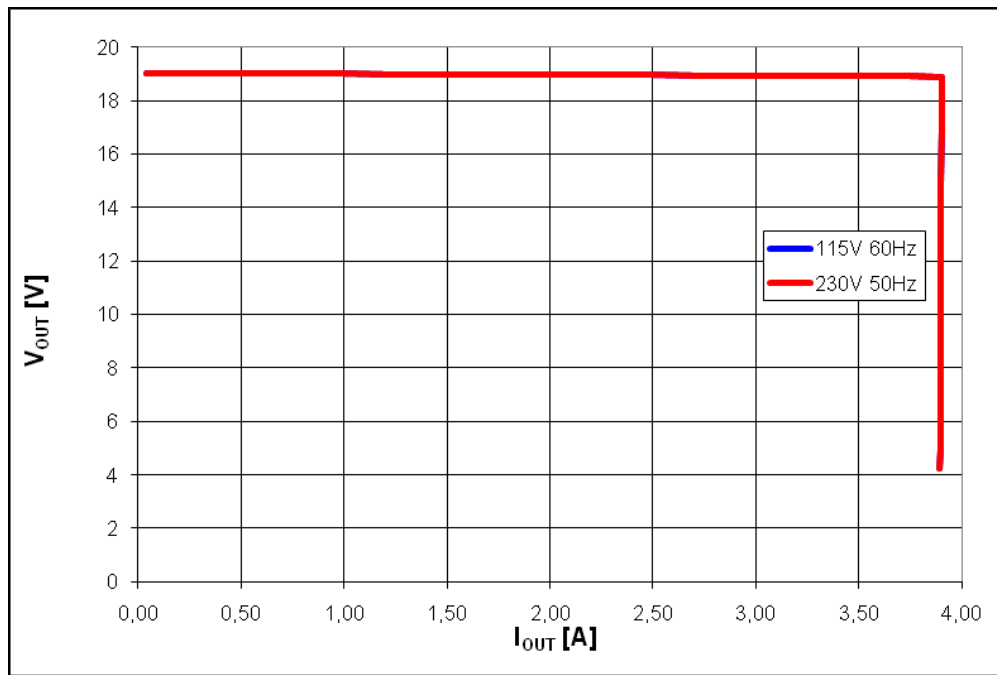

Figure 3. Load Regulation is 31.7 mV/A

Efficiency

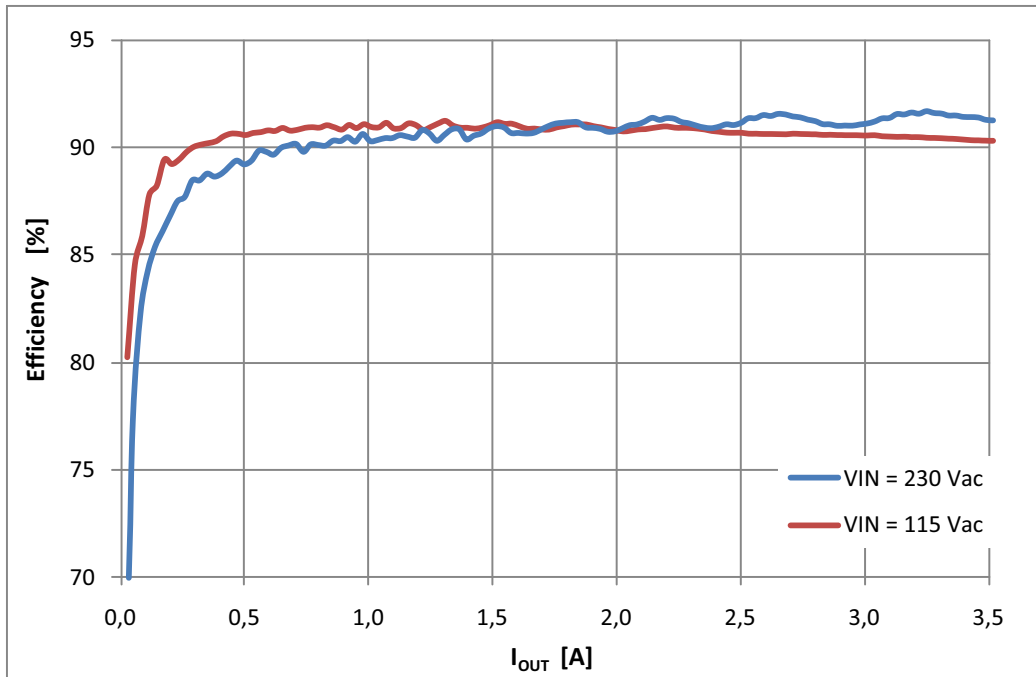

Figure 4. Converter Efficiency for Low and High Line

NCP4354AADAPGEVB

Output Voltage Ripple

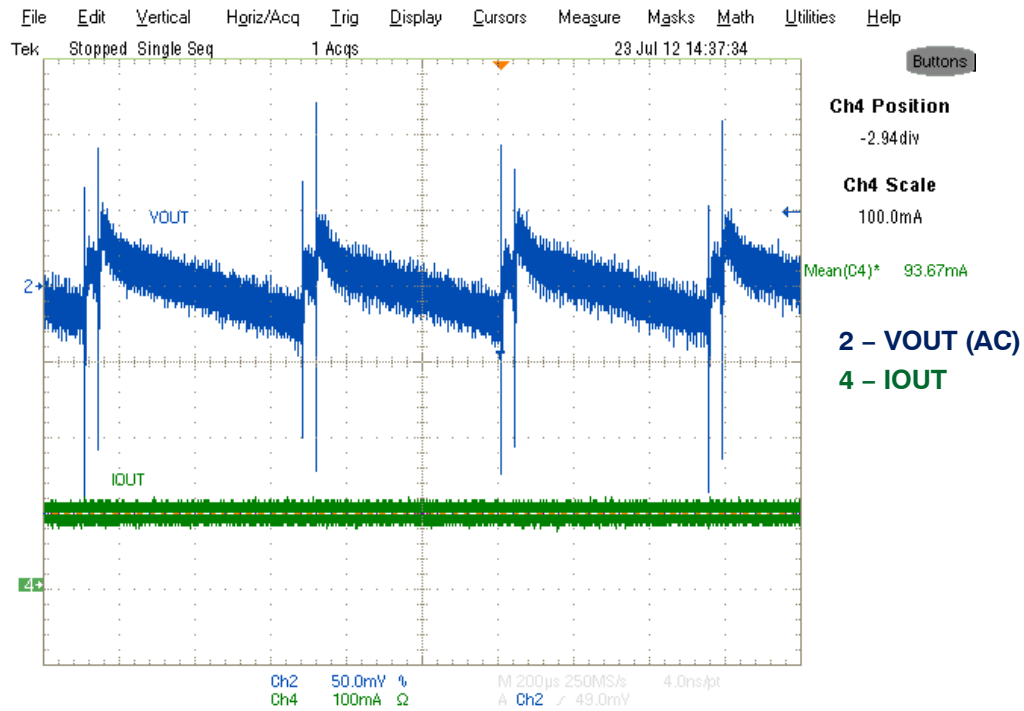

Figure 5. $V_{IN} = 230 V_{AC}$, $I_{OUT} = 100 mA$, Primary Controller is in Skip Mode, $\Delta V_{OUTPK-PK} = 90 mV$

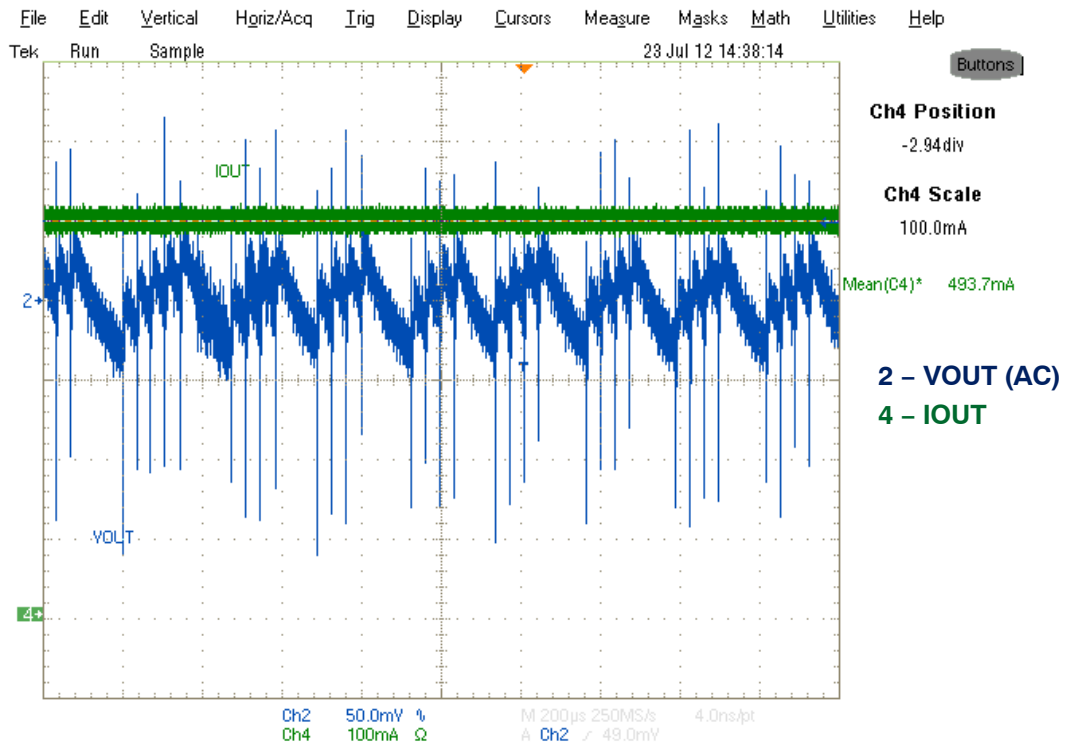

Figure 6. $V_{IN} = 230 V_{AC}$, $I_{OUT} = 500 mA$, $\Delta V_{OUTPK-PK} = 90 mV$

NCP4354AADAPGEVB

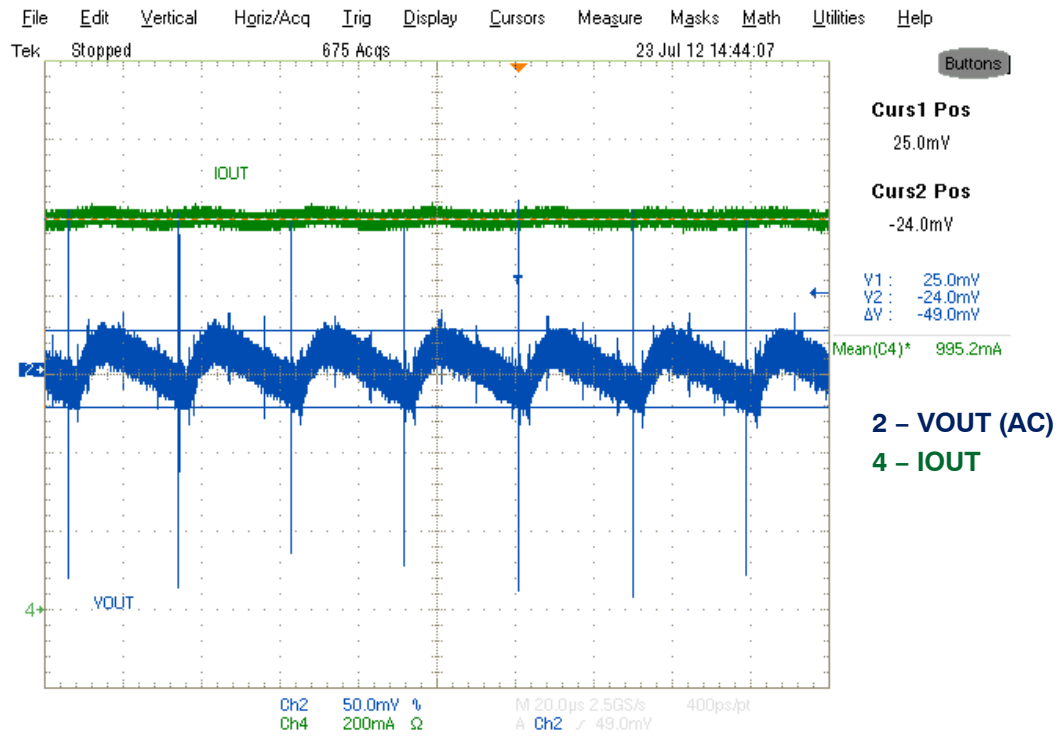

Figure 7. $V_{IN} = 230 V_{AC}$, $I_{OUT} = 1.0 A$, $\Delta V_{OUTPK-PK} = 50 mV$

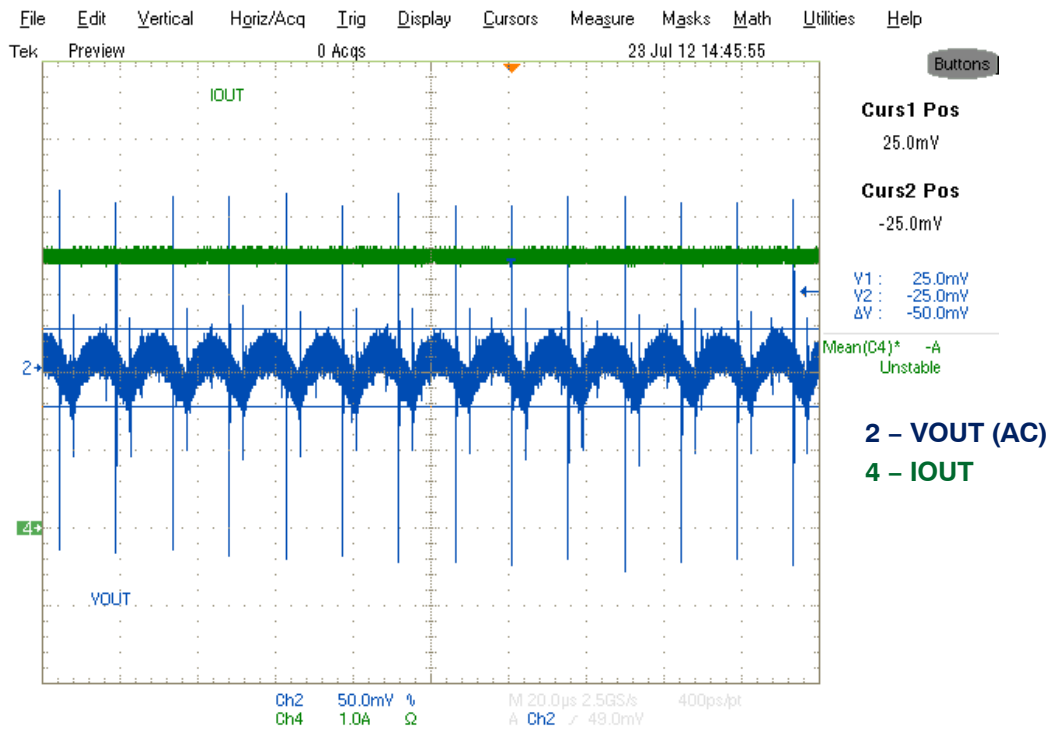

Figure 8. $V_{IN} = 230 V_{AC}$, $I_{OUT} = 3.5 A$, $\Delta V_{OUTPK-PK} = 50 mV$

NCP4354AADAPGEVB

OFF Mode

Off-mode is activated, when output current is below set level. In this design, the off-mode threshold is set to approximately 3.5 mA. This condition is detected by OFFDET comparator through additional rectifier (D105) with bulk capacitor (C106) and voltage divider (R115 and R116). C106 charging current is limited by R114 to avoid full recharge of C106 by short and sporadic pulses in deep skip mode. When very light load is detected, ONOFF current starts to be sunk by the DRIVE pin. The internal pull up current source is connected to VSNS pin and increases its voltage (Figure 10 A). Thanks to this current, voltage OTA starts to sink limited current to help ONOFF current pull the

primary FB voltage below the off mode detection level (Figure 11 B). When the primary side detects off mode, FB pull up current is decreased to save energy. After that the FB pull down current through optocoupler can be lower. The secondary side stops sinking additional current by voltage OTA after VSNS voltage drops below VREF to save output capacitor energy (Figure 12 C). Off mode is interrupted when VOUT falls below the VMIN threshold that is detected by VMIN comparator (Figure 9 D). ONOFF current then disappears and primary side FB voltage increases. When primary FB voltage is within operation range, the primary controller starts to operate. The output capacitor is then recharged to nominal output voltage.

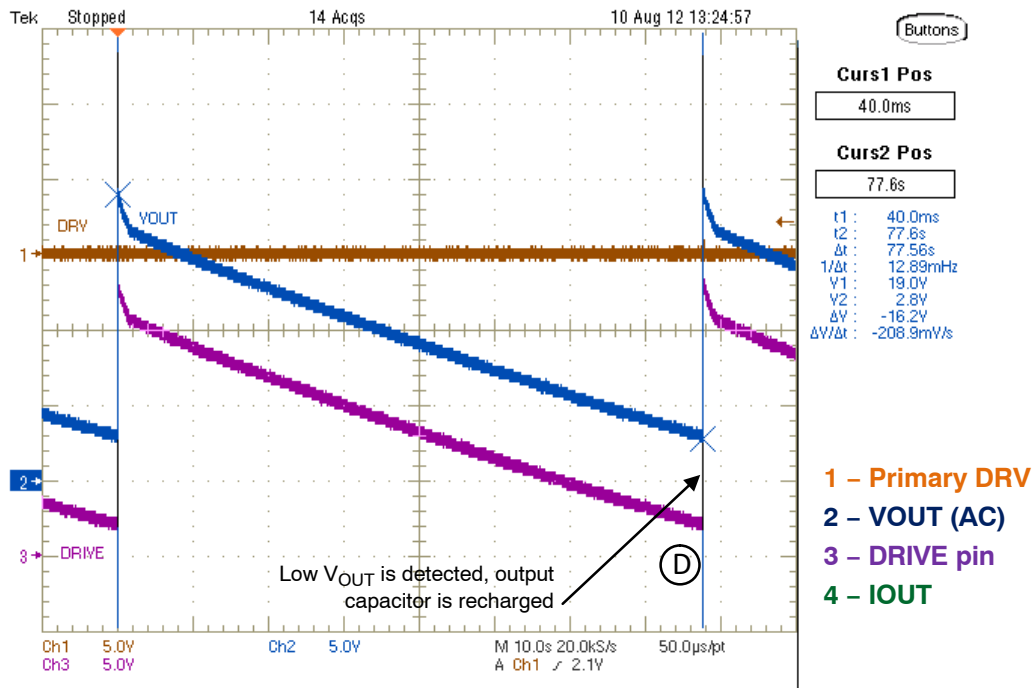

Figure 9. $V_{IN} = 230 V_{AC}$, $I_{OUT} = 0 A$, Off-mode Period $t_{OFFMODE} = 77.5 s$, $V_{OUTMIN} = 2.8 V$

NCP4354AADAPGEVB

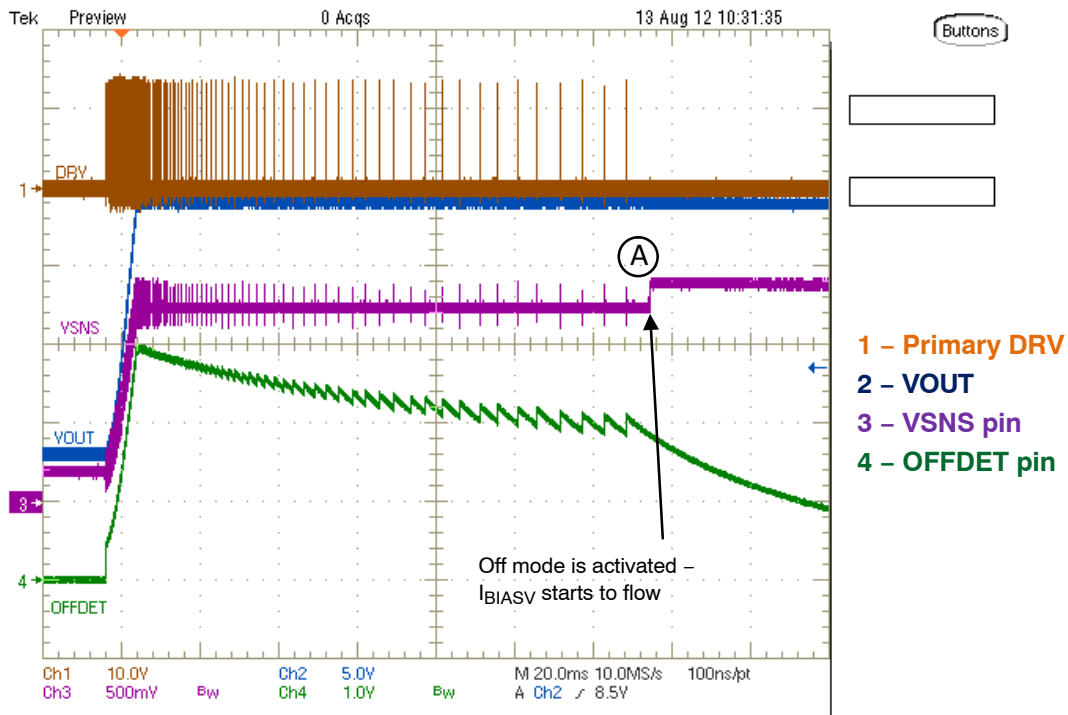

Figure 10. $V_{IN} = 230 V_{AC}$, $I_{OUT} = 0 A$, Output Capacitor Recharge when V_{OUT} drops below V_{MIN} Level in Off-mode

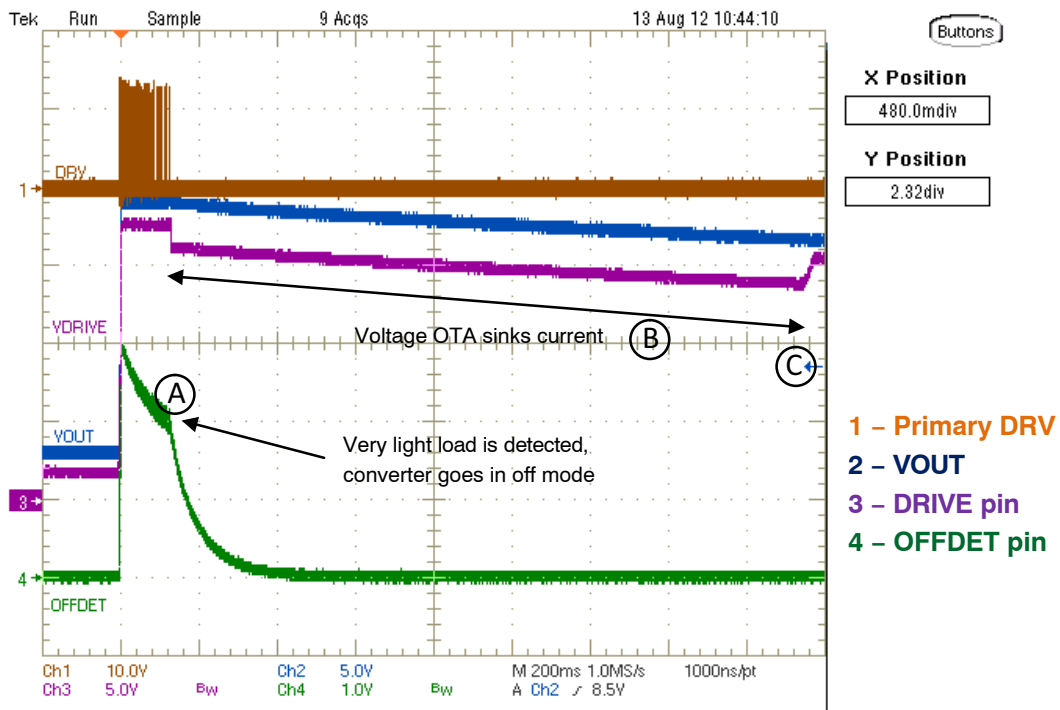

Figure 11. $V_{IN} = 230 V_{AC}$, $I_{OUT} = 0 A$, ON-mode to OFF-mode Transition.

The voltage drop on the DRIVE pin indicates the higher voltage OTA sink current (1.5 mA) at time 200 ms after OFF-mode trigger. During this time, the VSNS pin is connected to a 10 mA pull up current source, which increases the voltage at VSNS pin. The OTA stops sinking current 1700 ms after trigger, because VSNS voltage drops below V_{REF} .

There is only I_{ONOFF} current sunk through OPTO after $V_{SNS} < V_{REF}$.

NCP4354AADAPGEVB

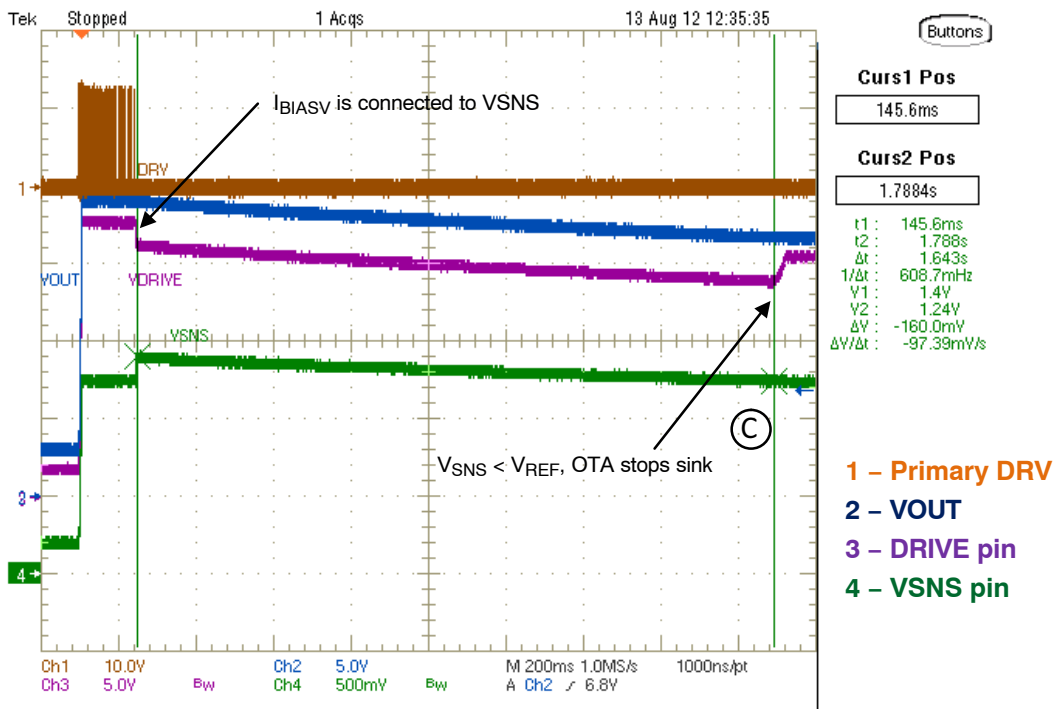

Figure 12. $V_{IN} = 230 V_{AC}$, $I_{OUT} = 0 A$, Same Condition as is shown in Figure 11, but V_{OFFDET} is replaced by $VSNS$. This waveform shows the time when internal current source (I_{BIASV}) is connected to $VSNS$. This allows voltage OTA to sink less current until $VSNS$ voltage is higher than V_{REF} .

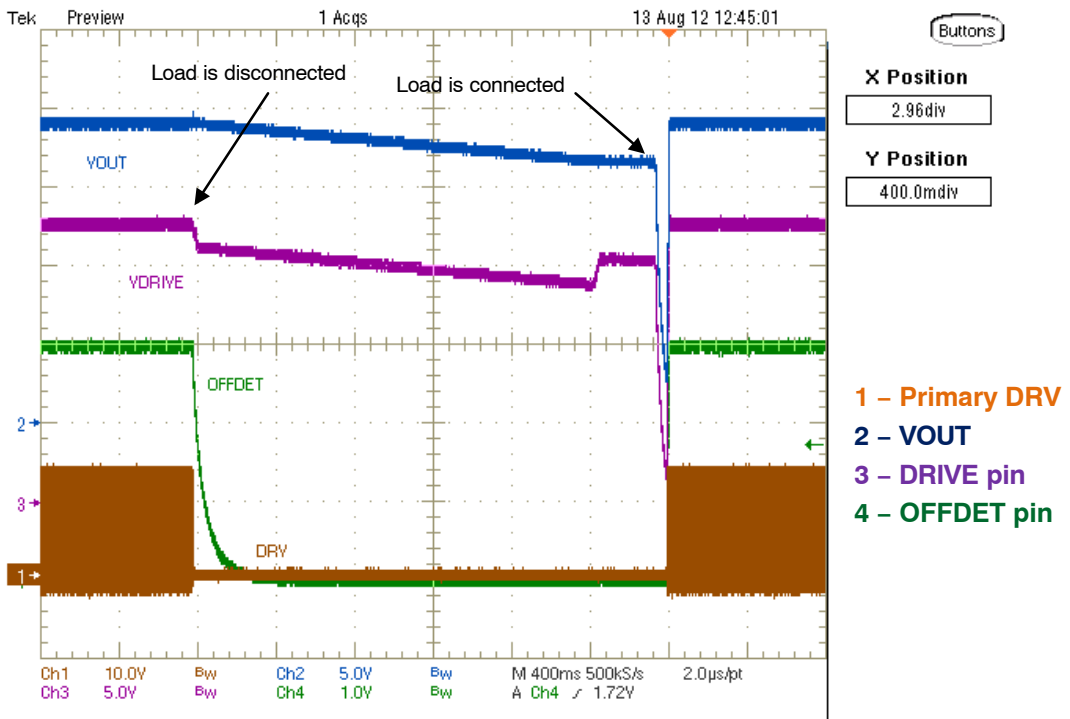

Figure 13. $V_{IN} = 230 V_{AC}$, $I_{OUT} = 0 A$, 20Ω Load Resistor is connected to the Output in Off Mode V_{OUT} quickly drops below V_{MIN} voltage and primary side starts to operate again. The DRV waveform shows the point when voltage OTA stops sinking current, because $VSNS$ voltage drops below V_{REF} level.

NCP4354AADAPGEVB

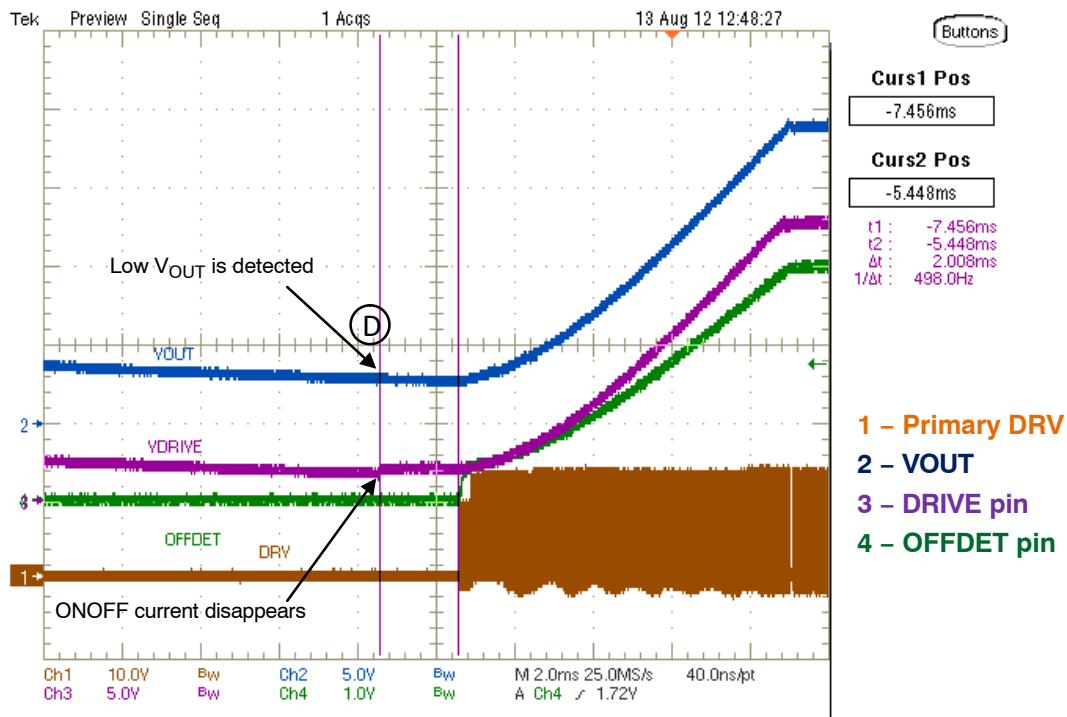

Figure 14. $V_{IN} = 230 V_{AC}$, $I_{OUT} = 0 A$, zoomed Situation from Figure 13. Cursors show time (3.13 ms) that is necessary to switch primary side from OFF mode to normal operation. The DRIVE waveform shows a small voltage change when V_{OUT} is lower than V_{MIN} and ONOFF current is switched off.

Load Detection Speed Up Circuit

When a load is connected to the SMPS in off mode, the output capacitors have to be discharged below V_{MIN} level in order to re-start the primary side. The output capacitor discharging may take too long for some applications. Figure 15 shows an external speed up circuit (load detection circuit) that consists of D112, R124, R125, Q100, C6 and removed R123. This circuit uses the NCP4354A OFFDET pin. When the OFFDET voltage goes above 10% of V_{CC} threshold, off mode is ended. Raising the OFFDET voltage can be used to end OFF mode sooner than waiting for V_{OUT} to drop below V_{MIN} level. When there is no load in off mode,

output capacitors C8, C9, C10 are discharged slower than VCC capacitors C6 and C109, so at VCC the voltage is $V_{OUT} - V_{D109}$ and transistor Q100 is not conducting. Once a load is connected to the SMPS output in OFF mode, the output capacitors start to be discharged faster by the load than the VCC capacitors are discharged by I_{CC} . The voltage difference between output capacitors and VCC capacitors forces Q100 to conduct current through R124 into the OFFDET divider. OFFDET voltage is increased by additional current and when it crosses 10% of VCC threshold, off mode is ended.

NCP4354AADAPGEVB

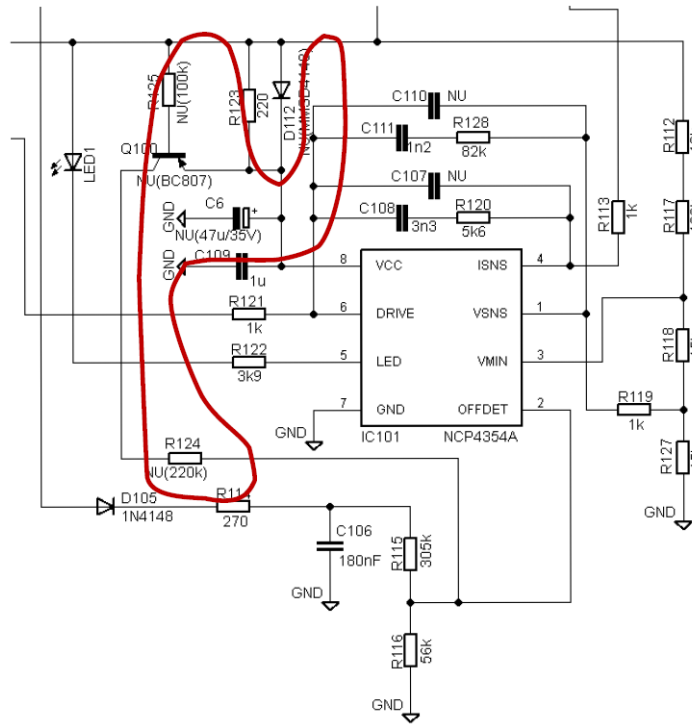

Figure 15. Speed up Circuit Schematic

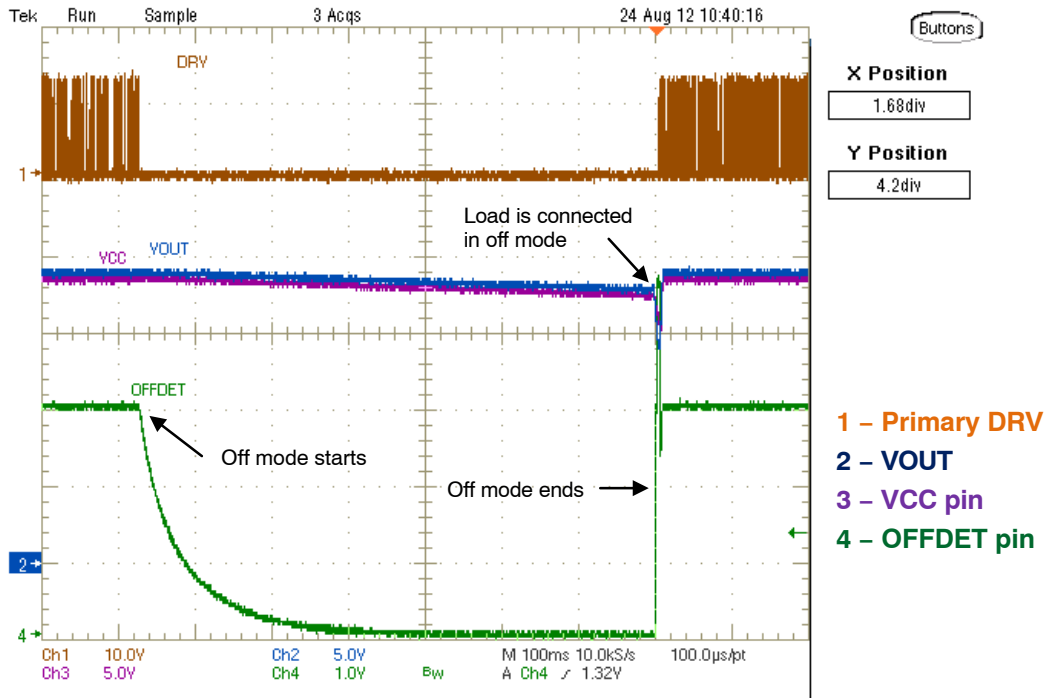

Figure 16. $V_{IN} = 230 \text{ VAC}$, $I_{OUT} = 0 \text{ A} \rightarrow 1 \text{ A}$, Load is connected to the Output of Off Mode

NCP4354AADAPGEVB

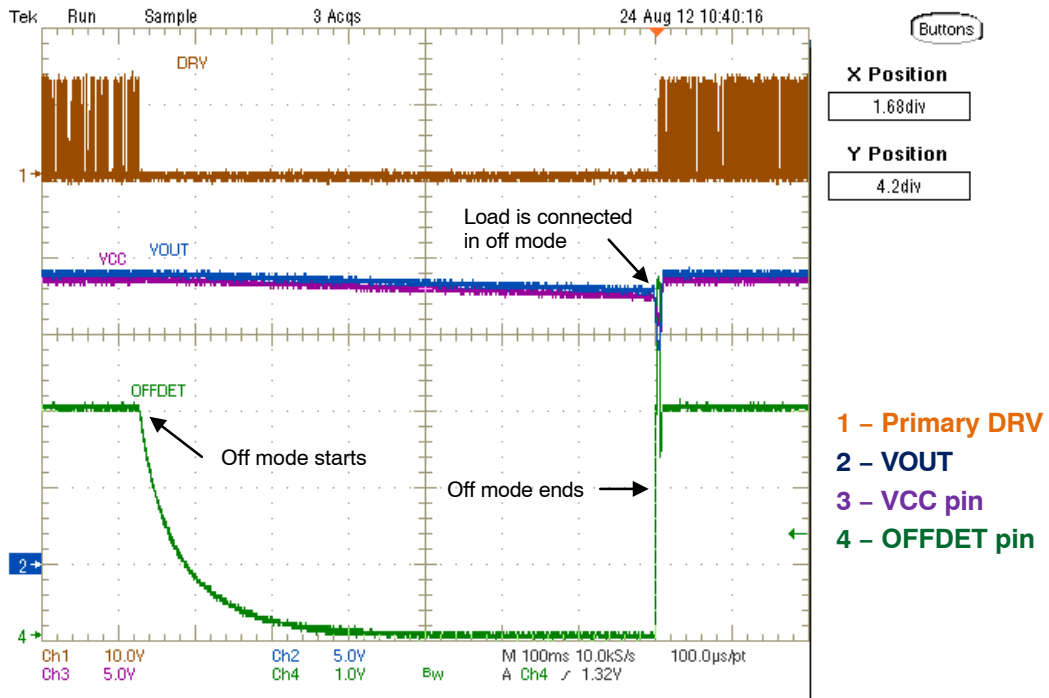

Figure 17. Zoomed Situation from Figure 16.
Cursors show time (4 ms) that elapsed from load connection to primary side turn-on.

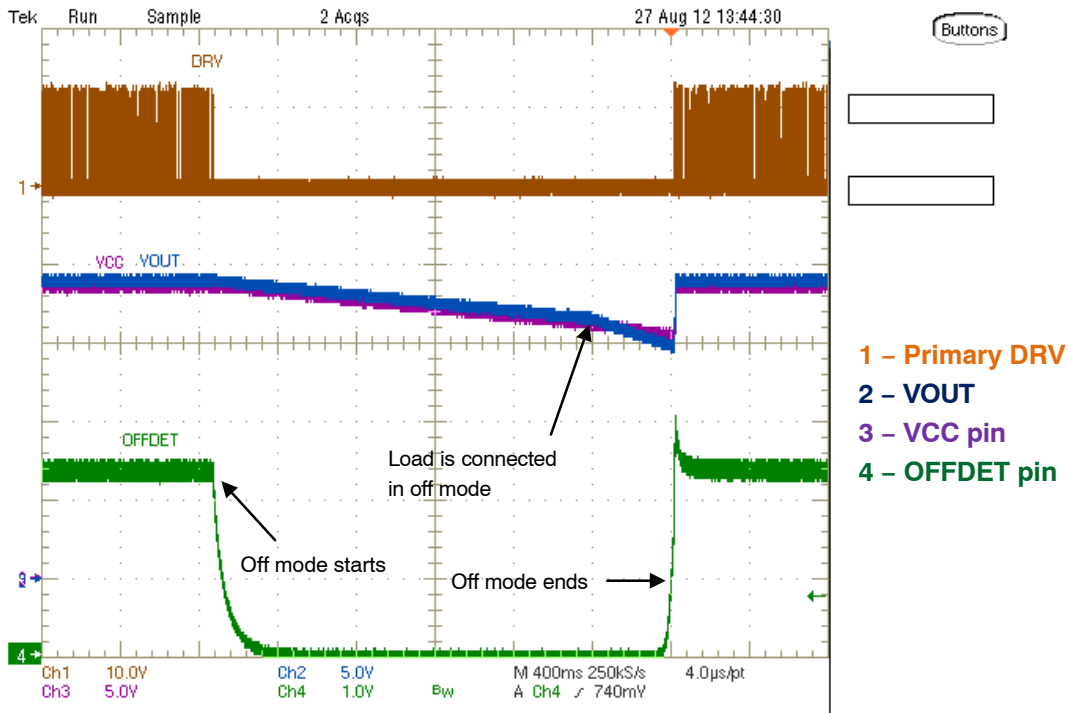

Figure 18. $V_{IN} = 230 \text{ VAC}$, $R_{LOAD} = 2 \text{ k}\Omega \rightarrow \infty \Omega \rightarrow 2 \text{ k}\Omega$, Load is connected to the Output in Off Mode

NCP4354AADAPGEVB

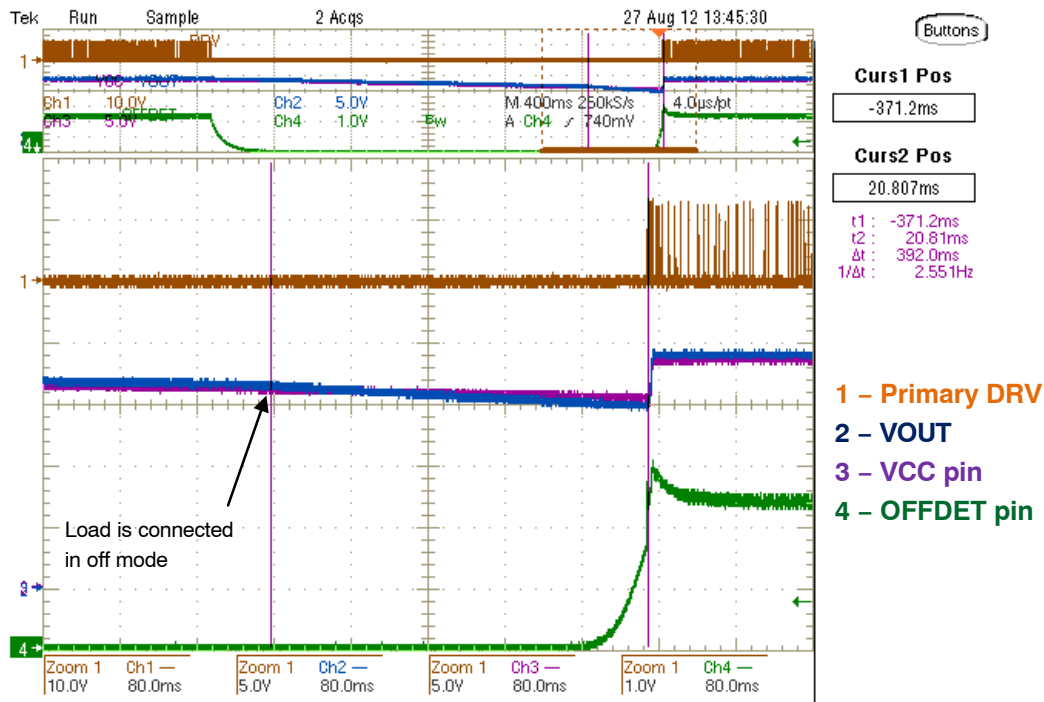

Figure 19. Zoomed Situation from Figure 18.

Cursors show time (392 ms) that elapsed from load connection to primary side turn-on.

Active X2 Capacitor Discharge

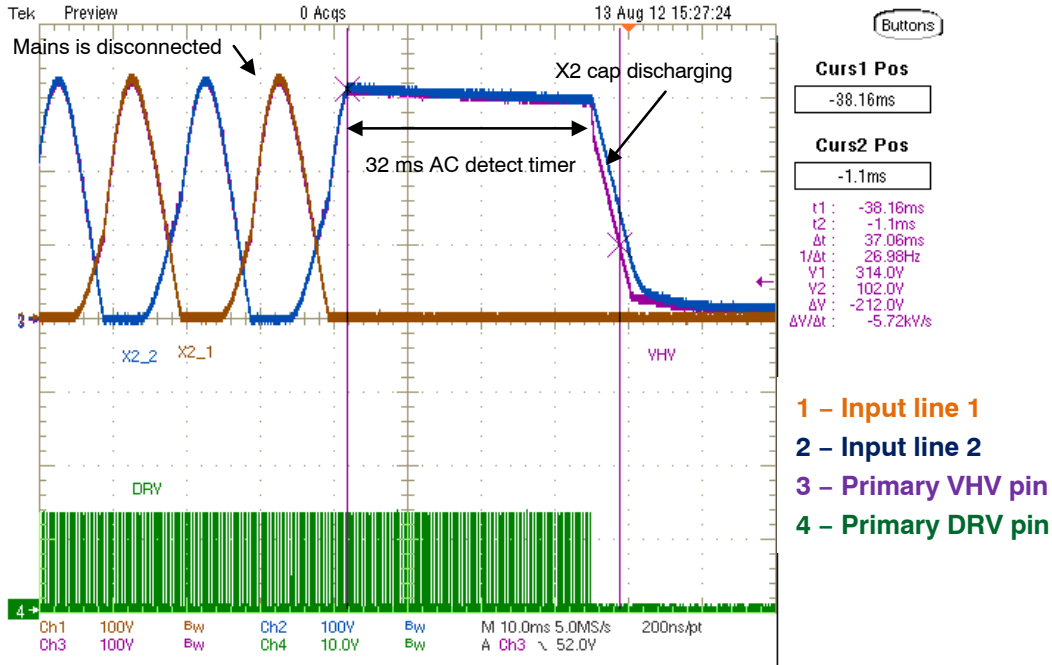

Figure 20. $V_{IN} = 230 V_{AC}$, $I_{OUT} = 1.0 A$, when the AC mains is disconnected, 32 ms detection timer is started. After this time, the X2 cap is discharged. Discharging time is much shorter than required by safety standards (37 ms << 1 s)

NCP4354AADAPGEVB

Transient Response

Output Current Transients

Current slew rate is 125 mA / 1 μ s for all transients.

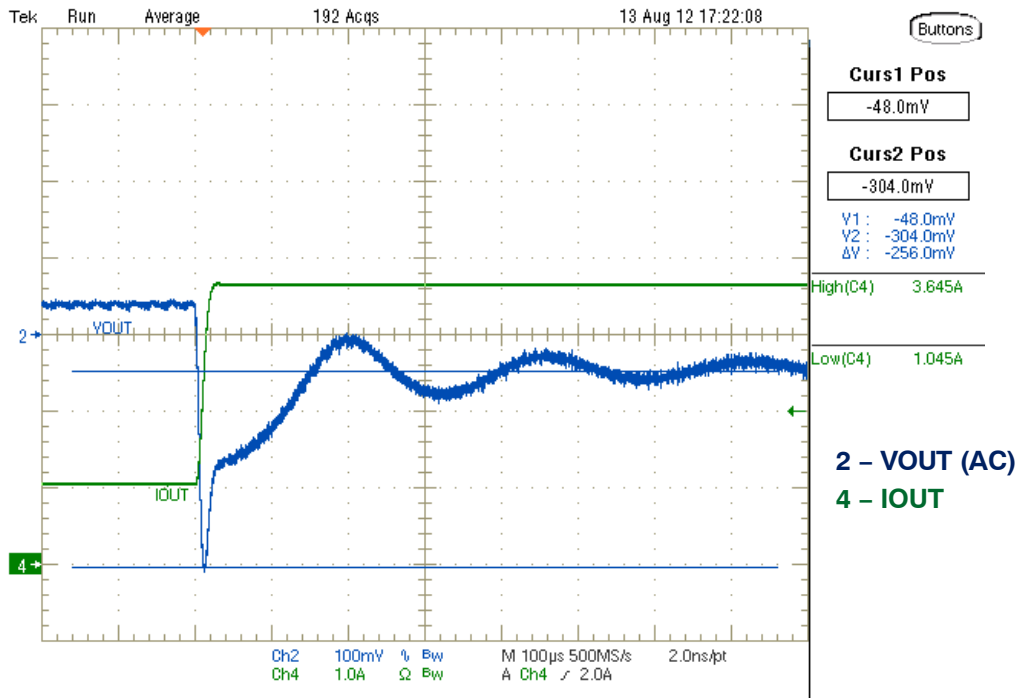

Figure 21. $V_{IN} = 115 V_{AC}$, $I_{OUT} = 1.0 - 3.5 A$, $V_{OUT_DROP} = 256 mV$

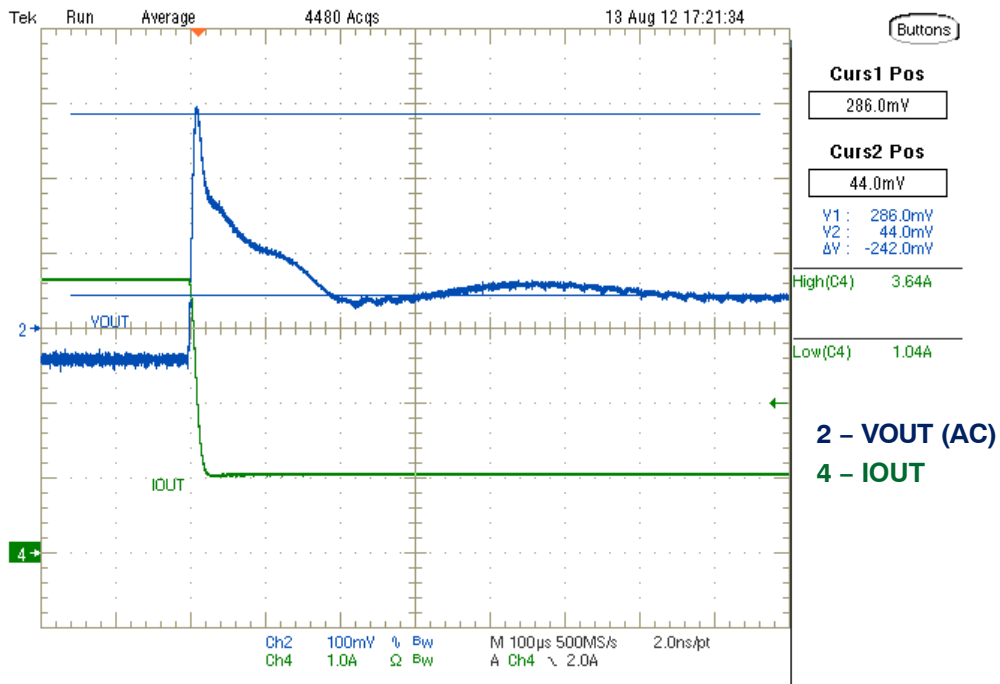

Figure 22. $V_{IN} = 115 V_{AC}$, $I_{OUT} = 3.5 - 1.0 A$, $V_{OUT_OVERSHOOT} = 242 mV$

NCP4354AADAPGEVB

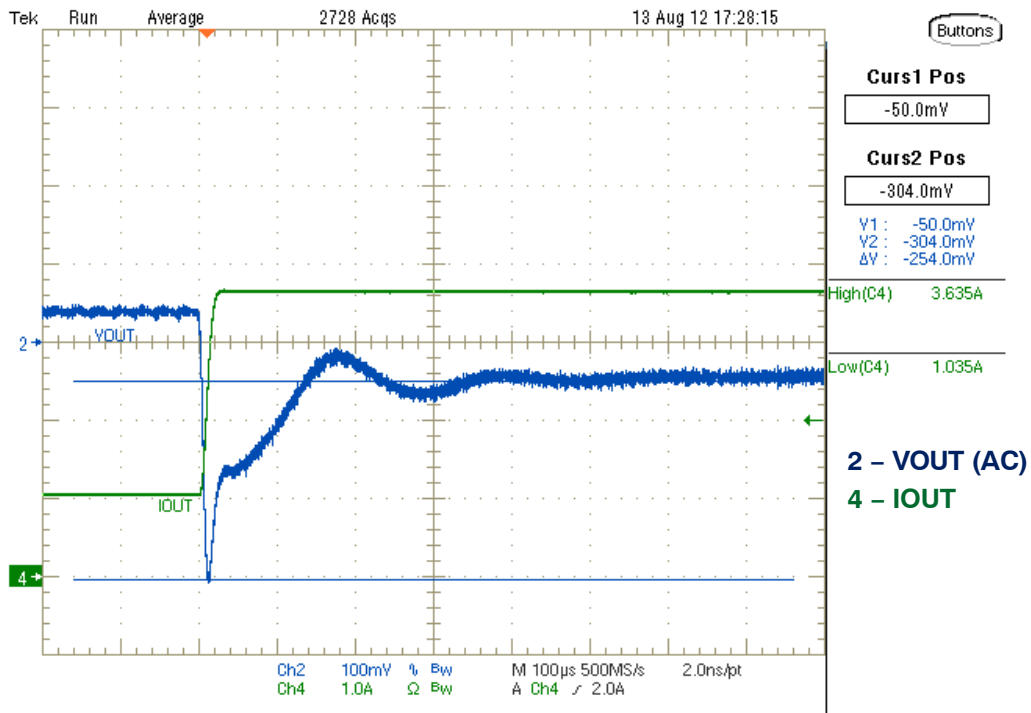

Figure 23. $V_{IN} = 230 V_{AC}$, $I_{OUT} = 1.0 - 3.5 A$, $V_{OUT_DROP} = 254 mV$

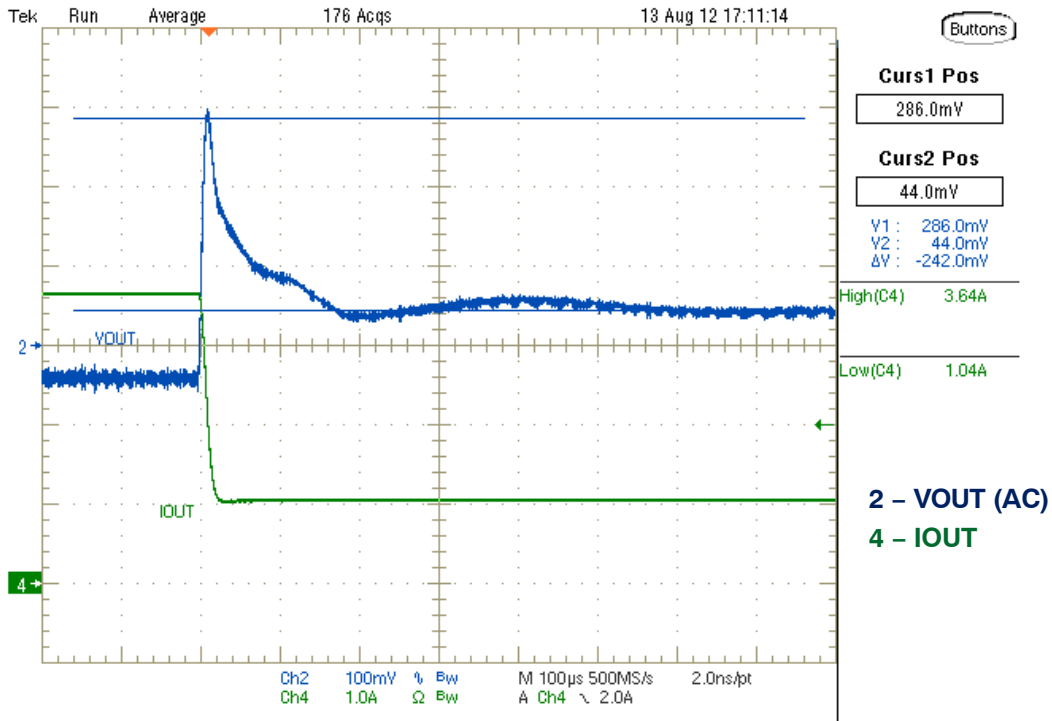

Figure 24. $V_{IN} = 230 V_{AC}$, $I_{OUT} = 3.5 - 1.0 A$, $V_{OUT_OVERSHOOT} = 242 mV$

NCP4354AADAPGEVB

Output Voltage Transients

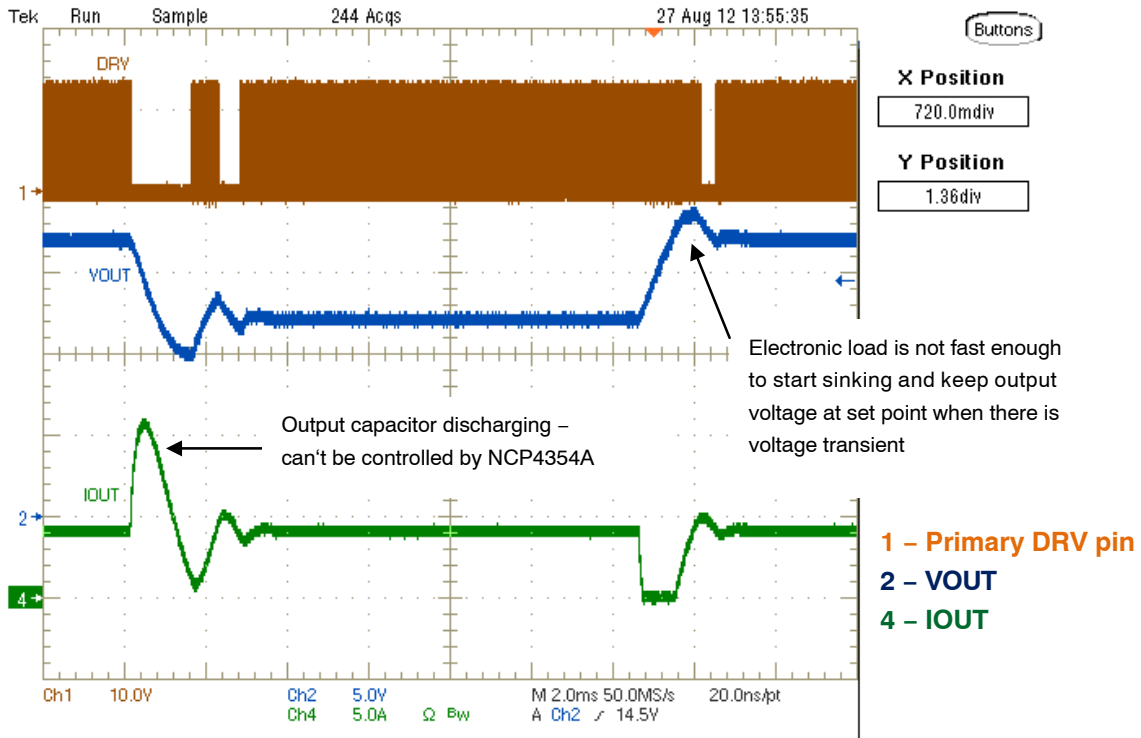

Figure 25. $V_{IN} = 230 V_{AC}$, $V_{OUT} = 12 - 17 V$

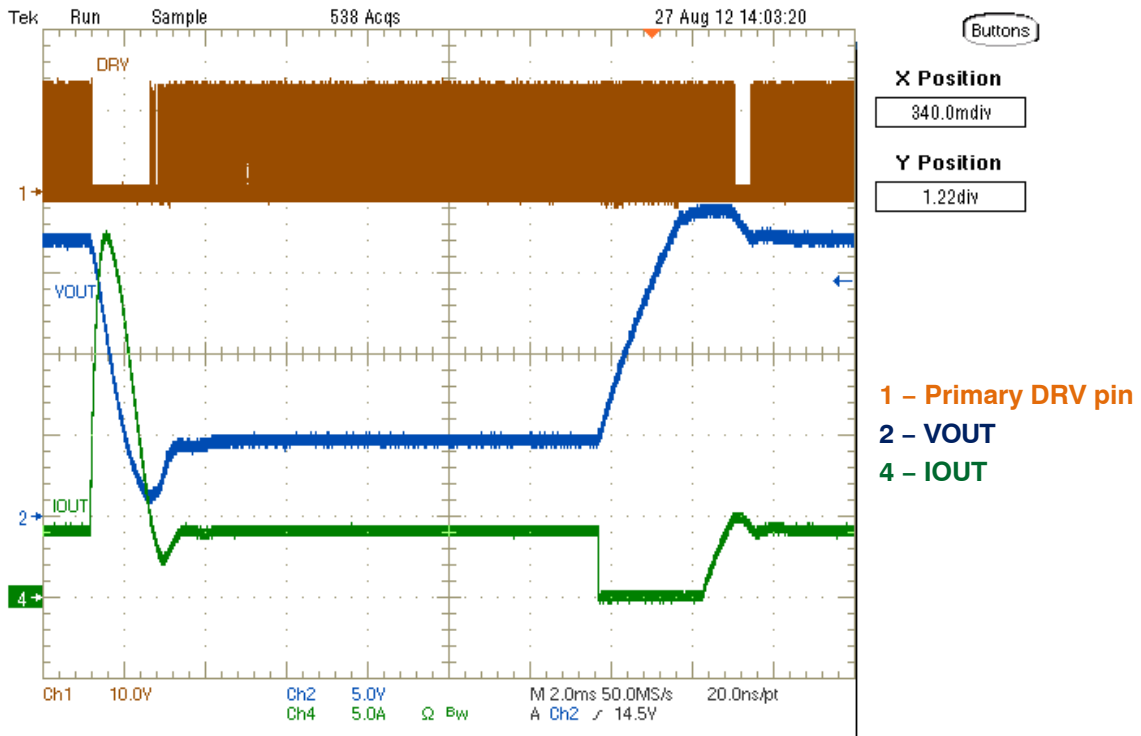

Figure 26. $V_{IN} = 230 V_{AC}$, $V_{OUT} = 5 - 17 V$

NCP4354AADAPGEVB

Output Voltage to Current Transient

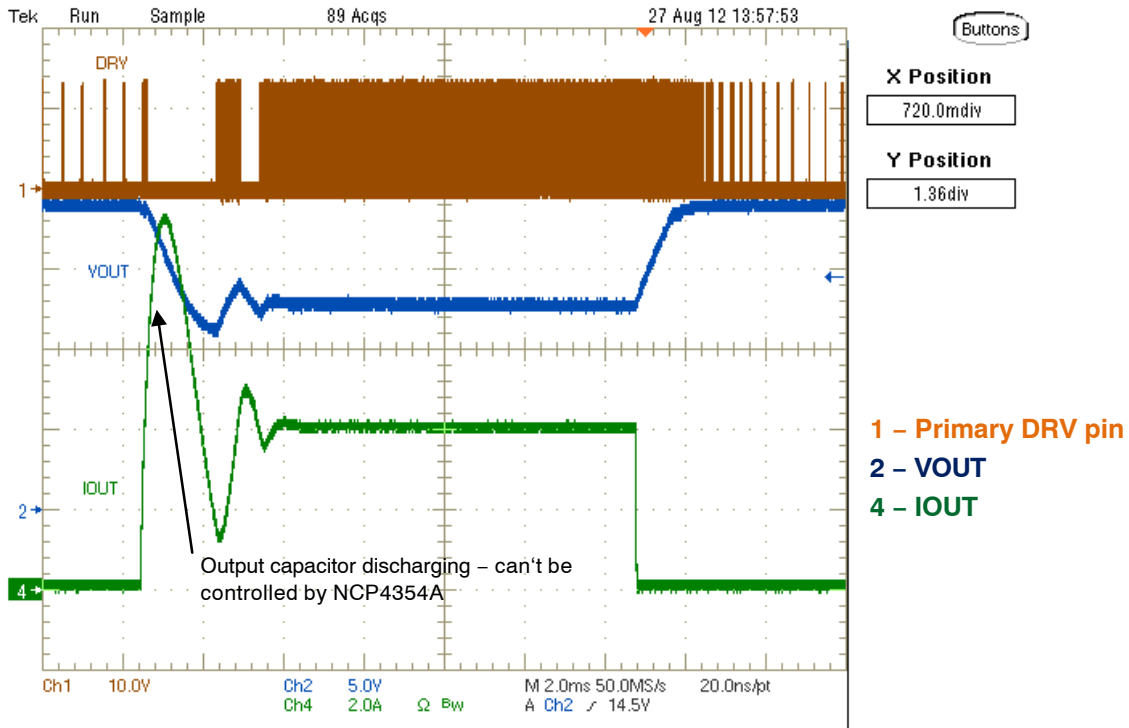

Figure 27. $V_{IN} = 230 V_{AC}$, $V_{OUT} = 12 V$ to $R_{OUT} = 200 \Omega$

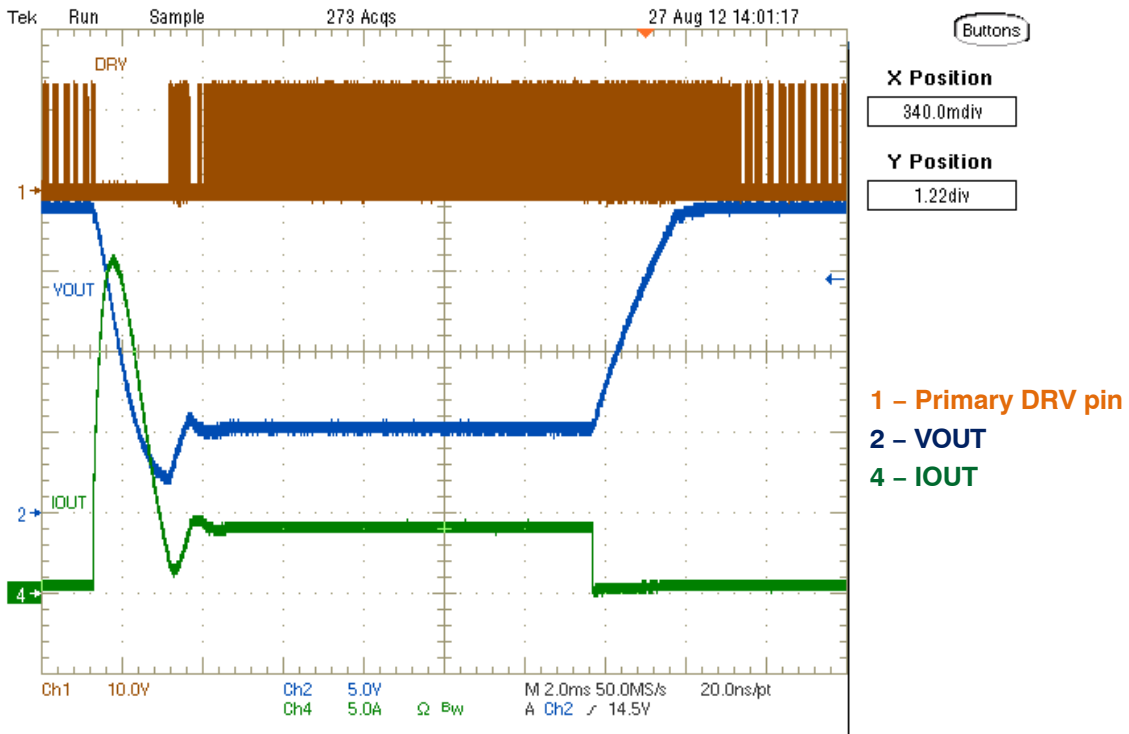

Figure 28. $V_{IN} = 230 V_{AC}$, $V_{OUT} = 5 V$ to $R_{OUT} = 40 \Omega$

NCP4354AADAPGEVB

Open Loop Transfer Characteristics

Voltage Control Loop Transfer Characteristic

Phase margin is never lower than 50°

Gain margin is never lower than 13 dB

Crossover frequency is between 0.6 – 0.75 kHz

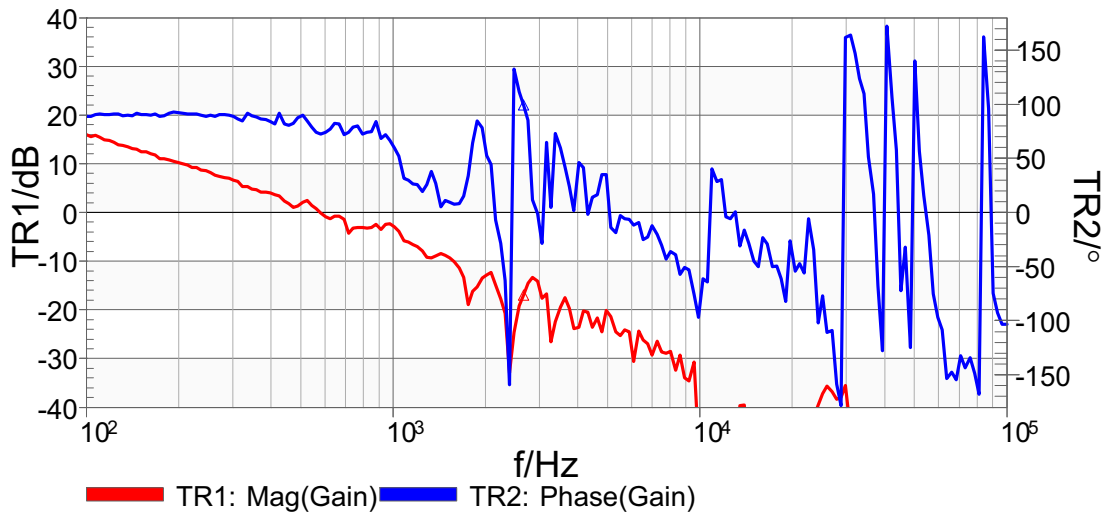

Figure 29. $V_{IN} = 85 V_{AC}$, $I_{OUT} = 100 \text{ mA}$

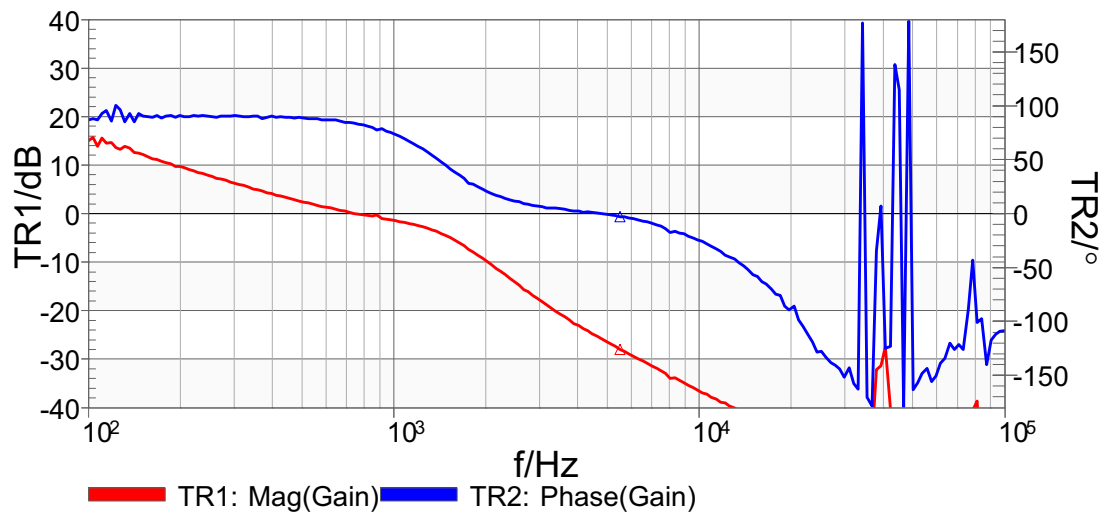

Figure 30. $V_{IN} = 85 V_{AC}$, $I_{OUT} = 1.0 \text{ A}$

NCP4354AADAPGEVB

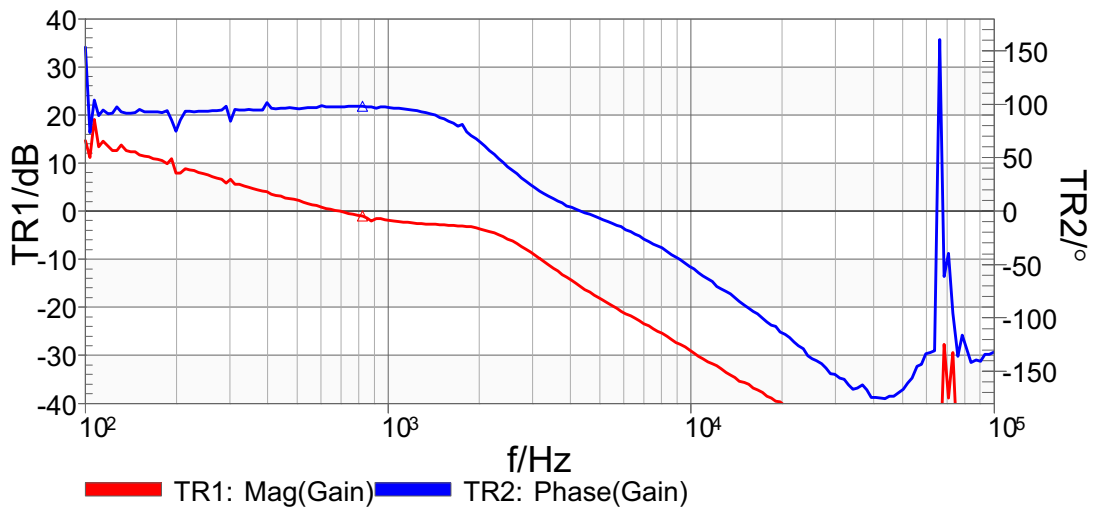

Figure 31. $V_{IN} = 85 V_{AC}$, $I_{OUT} = 3.5 A$

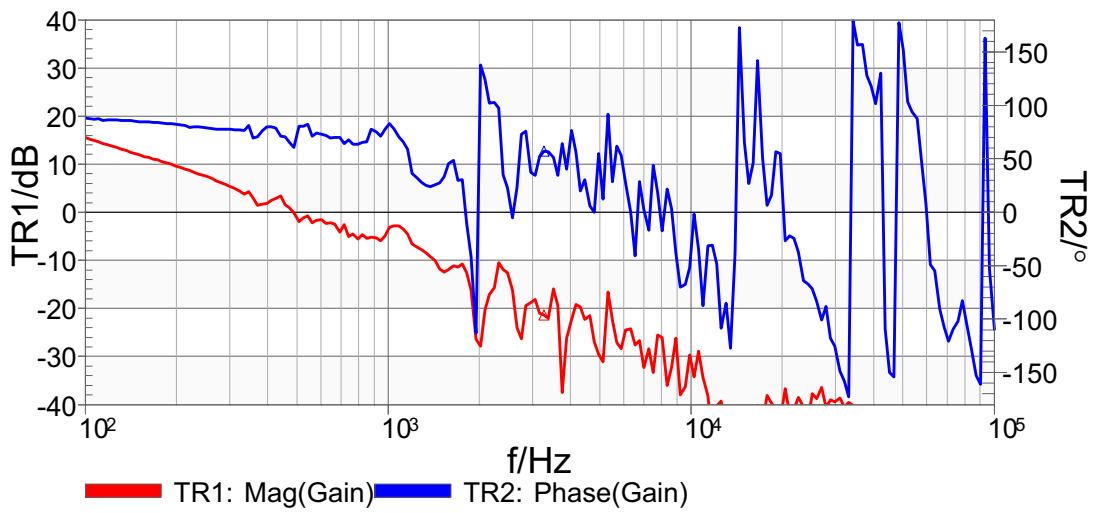

Figure 32. $V_{IN} = 265 V_{AC}$, $I_{OUT} = 100 mA$

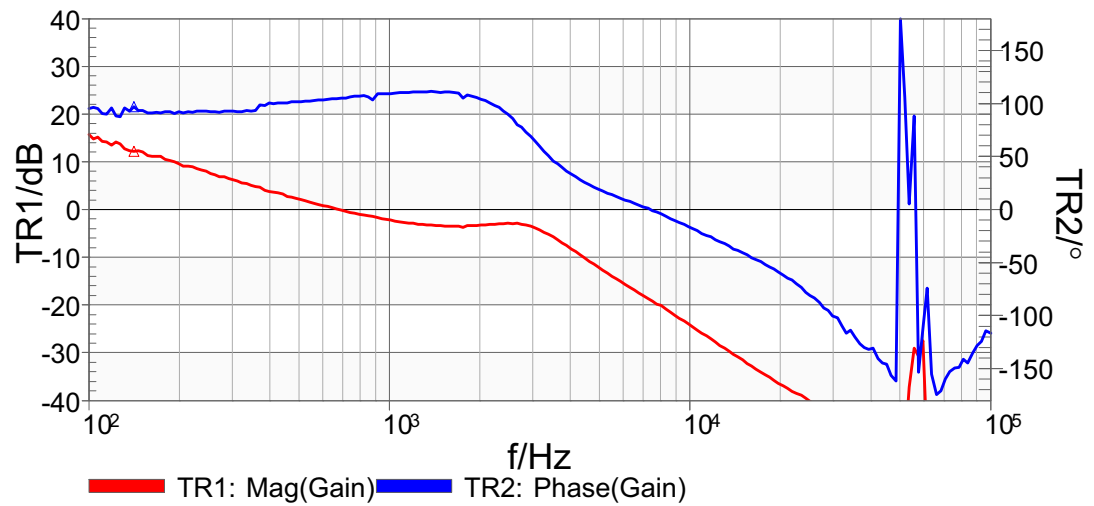

Figure 33. $V_{IN} = 265 V_{AC}$, $I_{OUT} = 2.0 A$

NCP4354AADAPGEVB

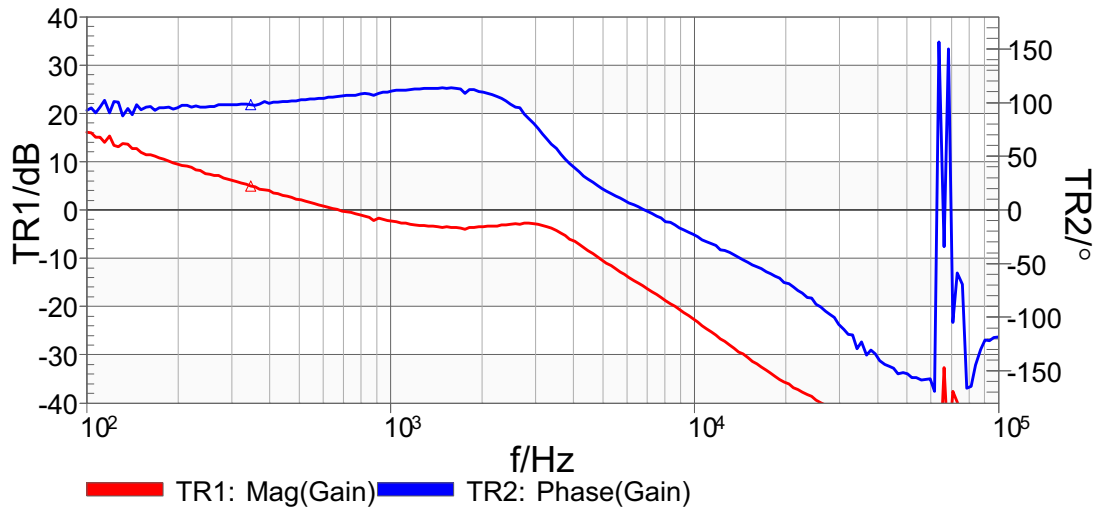

Figure 34. $V_{IN} = 265 V_{AC}$, $I_{OUT} = 3.5 A$

Current Control Loop Transfer Characteristic

Phase margin is never lower than 35°

Gain margin is never lower than 18 dB

Crossover frequency is between 100 – 200 Hz

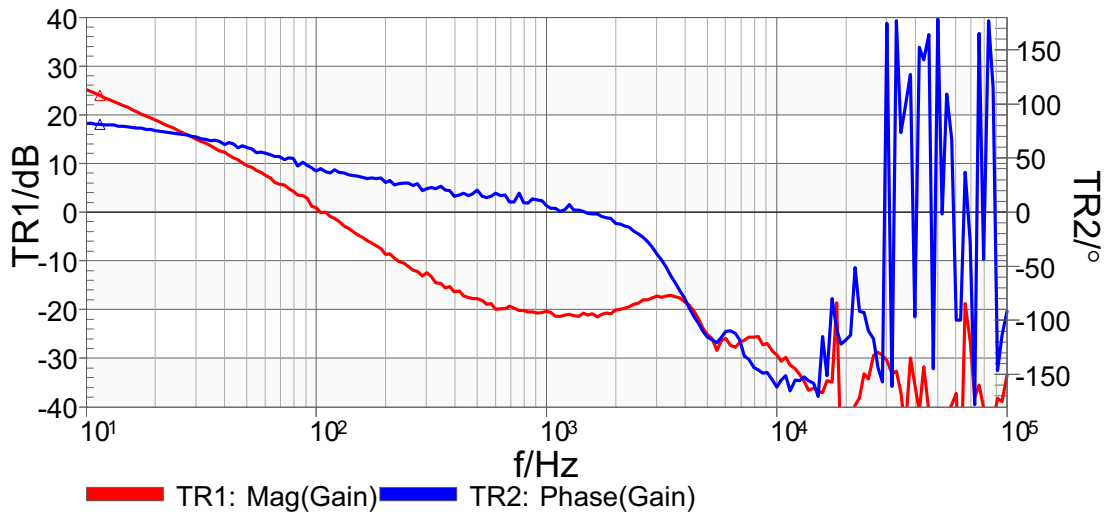

Figure 35. $V_{IN} = 230 V_{AC}$, $I_{OUT} = 3.9 A$, $V_{OUT} = 15 V$

NCP4354AADAPGEVB

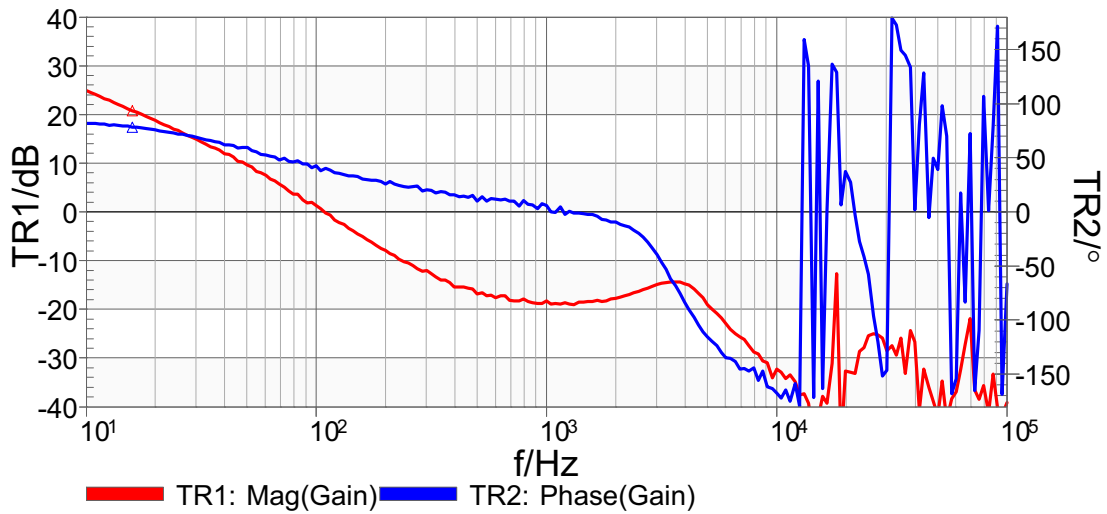

Figure 36. $V_{IN} = 115 V_{AC}$, $I_{OUT} = 3.9 A$, $V_{OUT} = 15 V$

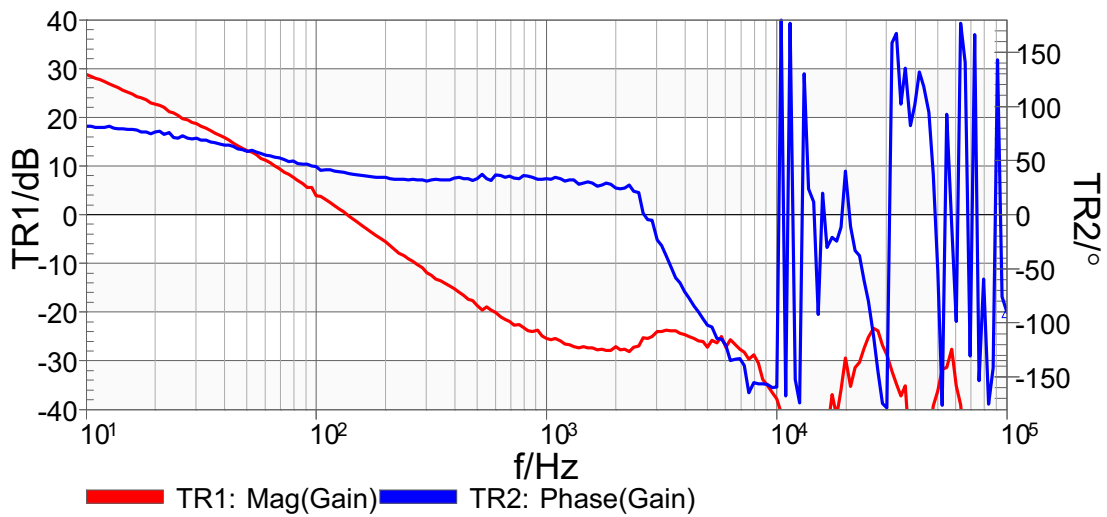

Figure 37. $V_{IN} = 230 V_{AC}$, $I_{OUT} = 3.9 A$, $V_{OUT} = 10 V$

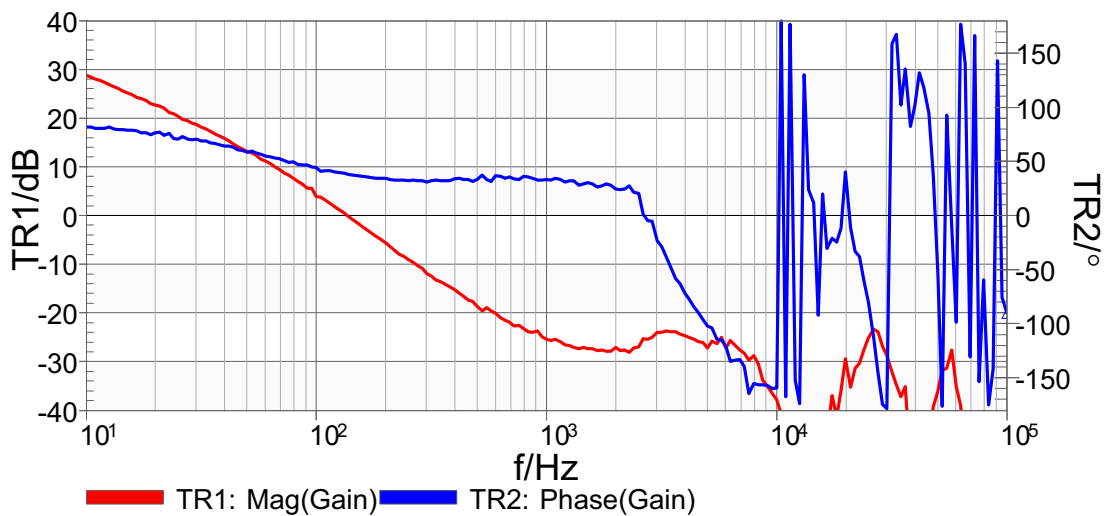

Figure 38. $V_{IN} = 115 V_{AC}$, $I_{OUT} = 3.9 A$, $V_{OUT} = 10 V$

NCP4354AADAPGEVB

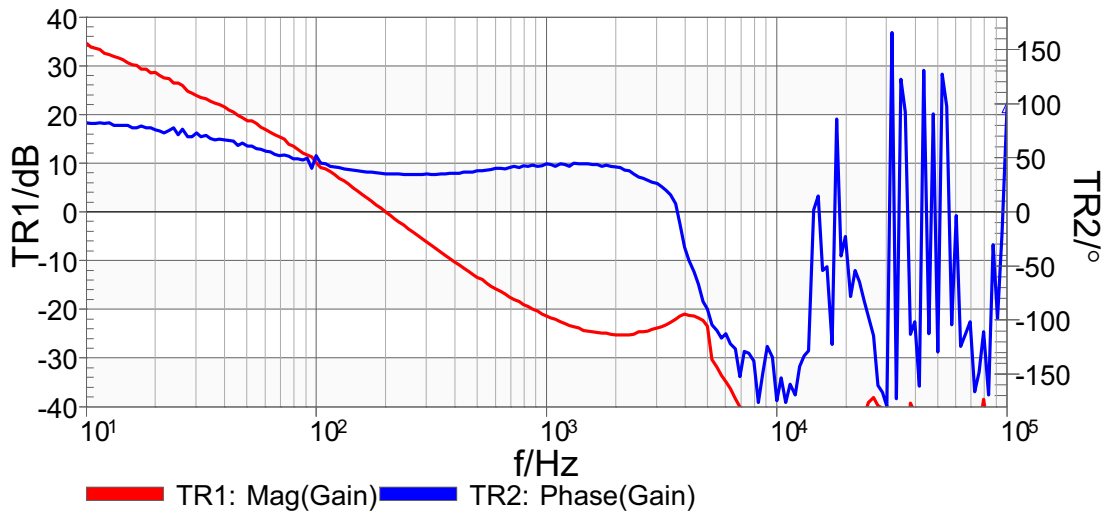

Figure 39. $V_{IN} = 230 V_{AC}$, $I_{OUT} = 3.9 A$, $V_{OUT} = 5 V$

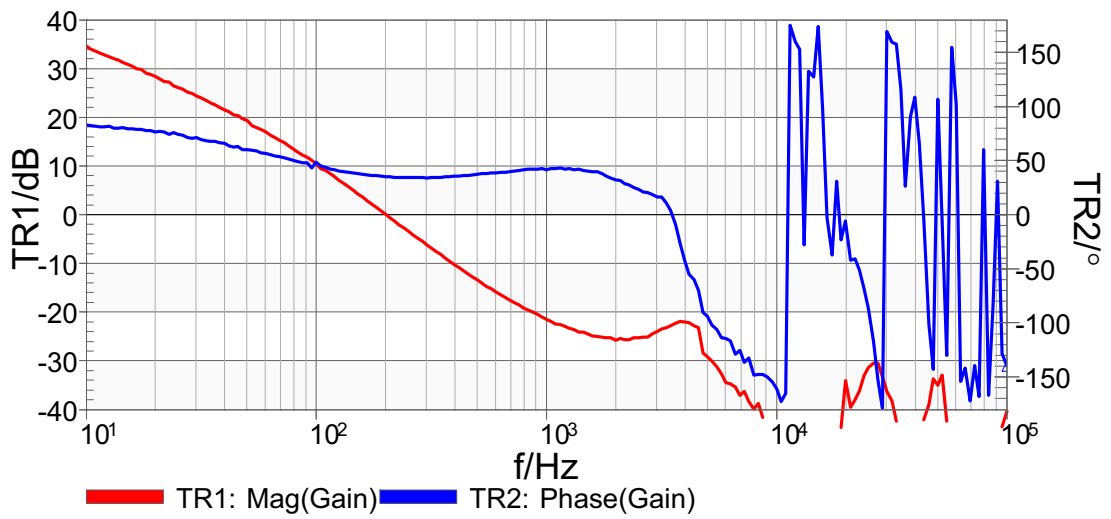

Figure 40. $V_{IN} = 115 V_{AC}$, $I_{OUT} = 3.9 A$, $V_{OUT} = 5 V$

NCP4354AADAPGEVB

Conducted Emission Quasi-peak

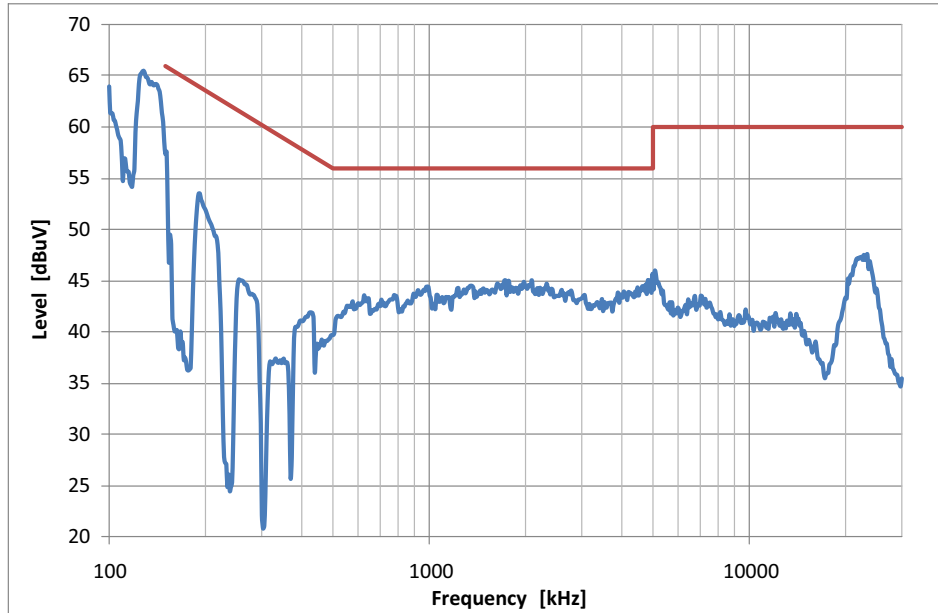

Figure 41. $V_{IN} = 115 V_{AC}$, $I_{OUT} = 3.5 A$

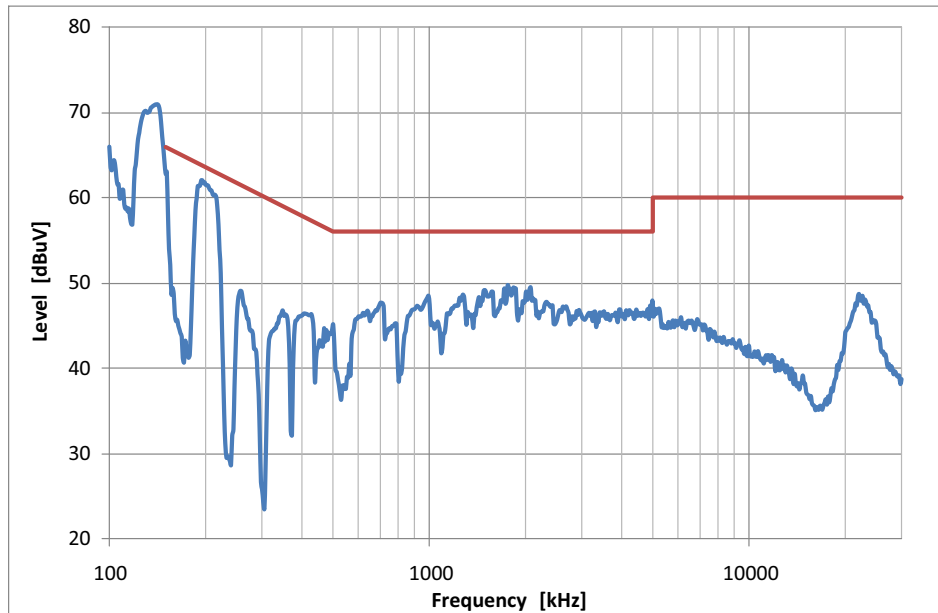

Figure 42. $V_{IN} = 230 V_{AC}$, $I_{OUT} = 3.5 A$

Result Summary

The NCP1246 and NCP4354 controllers allow building cost effective, easy to design and high efficiency power supplies with very low no load input power consumption.

Special thanks go to companies Coilcraft, Epcos and Würth that provided samples of their components for this evaluation board.

NCP4354AADAPGEVB

Top Side Assembly

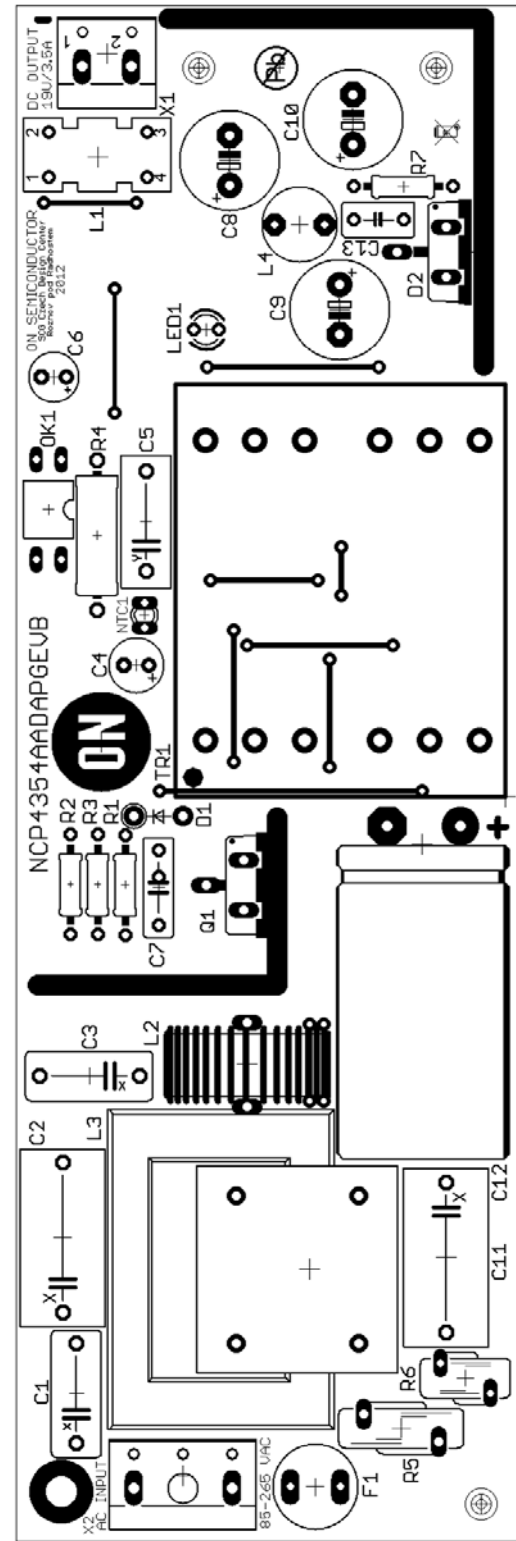

Figure 43. Top Side Assembly

NCP4354AADAPGEVB

Bottom Side Assembly

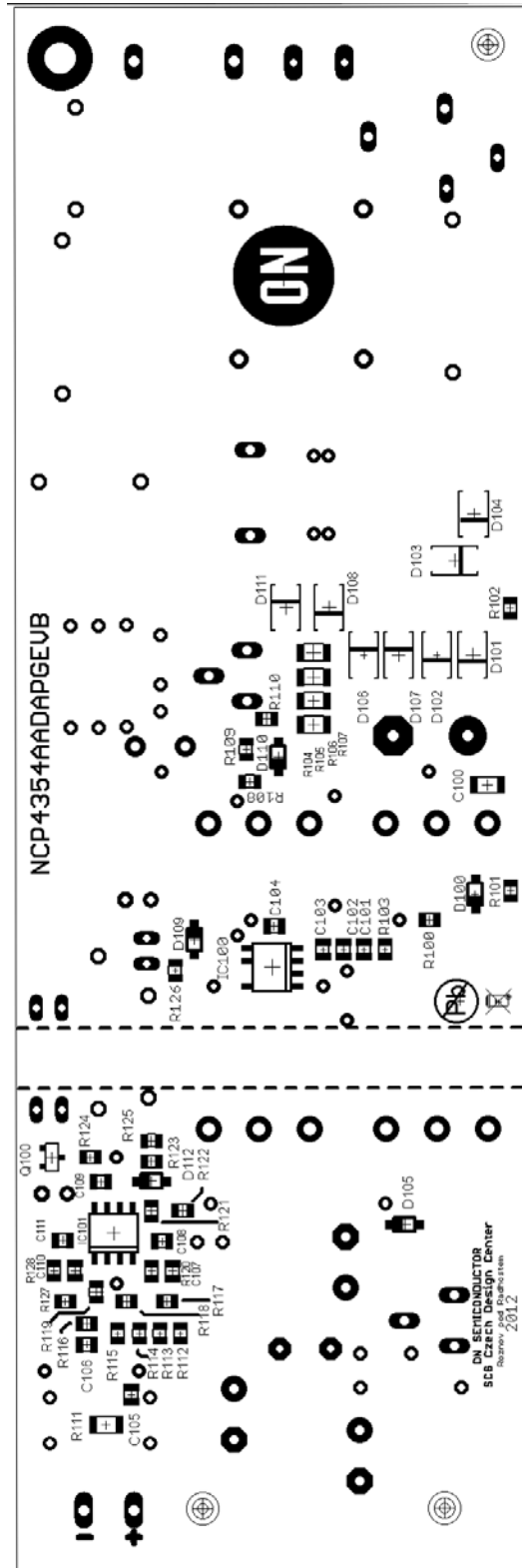

Figure 44. Bottom Side Assembly

NCP4354AADAPGEVB

Table 3. BILL OF MATERIAL

Designator	QTY	Description	Value	Tolerance	Footprint	Manufacturer	Manufacturer Part Number	Substitution Allowed	Lead Free
C100	1	Ceramic Capacitor	68 pF / 1000 V	5%	1206	Multicomp	MCCA000722	Yes	Yes
C101, C104	2	Ceramic Capacitor	100 nF	10%	0805	Kemet	C0805C104K5RAC	Yes	Yes
C102	1	Ceramic Capacitor	1.0 nF	10%	0805	Kemet	C0805C102K5RAC	Yes	Yes
C103, C107, C110	3	Ceramic Capacitor	NU	-	0805	-	-	Yes	Yes
C105	1	Ceramic Capacitor	33 nF	10%	0805	Kemet	C0805C333K5RAC	Yes	Yes
C106	1	Ceramic Capacitor	180 nF	10%	0805	Kemet	C0805C184K5RAC	Yes	Yes
C108	1	Ceramic Capacitor	3.3 nF	10%	0805	Kemet	C0805C332K5RAC	Yes	Yes
C109	1	Ceramic Capacitor	1.0 μ F		0805	Kemet	C0805C105K5RAC	Yes	Yes
C111	1	Ceramic Capacitor	1.2 nF	10%	0805	Kemet	C0805C122K5RAC	Yes	Yes
C12	1	Bulk Capacitor	100 μ F / 400 V	20%	Through Hole	United Chemi-Con	EKXG401ELL101MMN3S	Yes	Yes
C13	1	Ceramic Capacitor	1.2 nF / 630 V	5%	Disc - Radial	TDK Corporation	FK26C0G2J122J	Yes	Yes
C2, C11	2	Suppression Film Capacitors	100 nF	10%	Through Hole	Epcos	B32922C3104K	Yes	Yes
C4	1	Electrolytic Capacitor	47 μ F / 50 V	20%	Radial	Koshin	KLH-050V470ME110	Yes	Yes
C1, C3, C5	1	Ceramic Capacitor	2.2 nF / X1 / Y1	20%	Disc - Radial	Murata	DE1E3KX222MA5B	Yes	Yes
C6	1	Electrolytic Capacitor	NU (47 μ F / 50 V)	20%	Radial	Koshin	KLH-050V470ME110	Yes	Yes
C7	1	Ceramic Capacitor	5.6 nF / 630 V	5%	Radial	TDK Corporation	FK20C0G2J562J	Yes	Yes
C8, C9, C10	3	Electrolytic Capacitor	470 μ F / 25 V	20%	Radial	Panasonic - ECG	ECA-1EHG471	Yes	Yes
D1	1	Standard Recovery Rectifier	1N4007	-	DO41-10B	ON Semiconductor	1N4007G	No	Yes
D100, D110	2	Diode	MMSD4148	-	SOD123	ON Semiconductor	MMSD4148T3G	No	Yes
D101, D102, D103, D104, D105, D106, D107, D108, D111	8	Standard Recovery Rectifier	MRA4007	-	SMA	ON Semiconductor	MRA4007T3G	No	Yes
D109	1	Zener diode	MMSZ15	5%	SOD123	ON Semiconductor	MMSZ15T3G	No	Yes
D112	1	Diode	NU (MMSD4148)	-	SOD123	ON Semiconductor	MMSD4148T3G	Yes	Yes
D2	1	Diode Schottky 100 V, 30 A	NTST30100SG	-	TO220	ON Semiconductor	NTST30100SG	Yes	Yes
F1	1	Fuse (MST ser.)	1.6 A	-	Through Hole	Schurter Inc	0034.6617	Yes	Yes
IC100	1	Fixed Frequency Current Mode Controller for Flyback Converters	NCP1246B65	-	SOIC-08	ON Semiconductor	NCP1246BD065R2G	No	Yes
IC101	1	Secondary Side Off-Mode Controller	NCP4354A		SOIC-08	ON Semiconductor	NCP4354ADR2G	No	Yes
L1	1	WE-CMB Common Mode Choke	14 μ H	-	744 841 414	Würth Elektronik	744 841 414	Yes	Yes

NCP4354AADAPGEVB

Table 3. BILL OF MATERIAL

Designator	QTY	Description	Value	Tolerance	Footprint	Manufacturer	Manufacturer Part Number	Substitution Allowed	Lead Free
L2	1	WE-FI Leaded Toroidal Line Choke	150 μ H	20%	744 701 8	Würth Elektronik	744 701 8	Yes	Yes
L3	1	Power Line Choke	2 x 20 mH	-	B82734W	Epcos	B82734W2202B030	Yes	Yes
L4	1	WE-TI Radial Leaded Wire Wound Inductor	1.0 μ H	20%	Radial	Würth Elektronik	744 772 010	Yes	Yes
LED1	1	LED 3 mm Green	LED-3MM-GR-EEN	-	Through Hole	Vishay	TLHG4400	Yes	Yes
NTC1	1	Sensing NTC Thermistor	330 k Ω	5%	Disc - Radial	Vishay	NTCLE100E3334JB0	Yes	Yes
OK1	1	Optocoupler	PC817	-	4-DIP	Sharp	PC817X2J000F	Yes	Yes
Q1	1	N MOSFET Transistor	SPP11N60C3	-	TO220	Infineon	SPP11N60C3	Yes	Yes
Q100	1	Transistor PNP	NU (BC807-40)		SOT23	ON Semiconductor	BC807-40LT1G	Yes	Yes
R1	1	Resistor	2.2 Ω	1%	0207	Vishay	MBB02070C2208FRP00	Yes	Yes
R100, R108	2	Resistor SMD	2.2 Ω	1%	0805	Rohm	MCR10EZHL2R20	Yes	Yes
R101, R102	2	Resistor SMD	2.7 k Ω		0806	Rohm	MCR10EZPF2701	Yes	Yes
R103	1	Resistor SMD	680 Ω	1%	0805	Rohm	MCR10EZPF6800	Yes	Yes
R104, R105, R106, R107	4	Resistor SMD	1.0 Ω	1%	1206	Rohm	MCR18EZHL1R00	Yes	Yes
R109	1	Resistor SMD	22 Ω	1%	0805	Rohm	MCR10EZPF22R0	Yes	Yes
R110	1	Resistor SMD	10 k Ω	1%	0805	Rohm	MCR10EZPF1002	Yes	Yes
R111	1	Resistor SMD	16 m Ω	1%	1206	Panasonic	ERJ-8BWFR016V	Yes	Yes
R112	1	Resistor SMD	18 k Ω		0805	Rohm	MCR10EZPF1802	Yes	Yes
R113, R119, R121	3	Resistor SMD	1.0 k Ω	1%	0805	Rohm	MCR10EZPF1001	Yes	Yes
R114	1	Resistor SMD	270 Ω	1%	0805	Rohm	MCR10EZHF2700	Yes	Yes
R115	1	Resistor SMD	300 k Ω		0805	Rohm	MCR10EZPF3003	Yes	Yes
R116	1	Resistor SMD	56 k Ω		0805	Rohm	MCR10EZPF5602	Yes	Yes
R117	1	Resistor SMD	180 k Ω		0805	Rohm	MCR10EZPF1803	Yes	Yes
R118, R127	2	Resistor SMD	15 k Ω		0805	Rohm	MCR10EZPF1502	Yes	Yes
R120	1	Resistor SMD	5.6 k Ω		0805	Rohm	MCR10EZPF5601	Yes	Yes
R122	1	Resistor SMD	3.9 k Ω		0805	Rohm	MCR10EZPF3901	Yes	Yes
R123	1	Resistor SMD	220 Ω		0805	Rohm	MCR10EZPF2200	Yes	Yes
R124	1	Resistor SMD	NU (220 k Ω)		0805	Rohm	MCR10EZPF2203	Yes	Yes
R125	1	Resistor SMD	NU (100 k Ω)		0805	Rohm	MCR10EZPF1003	Yes	Yes
R126	1	Resistor SMD	33 k Ω		0805	Rohm	MCR10EZPF3302	Yes	Yes
R128	1	Resistor SMD	82 k Ω		0805	Rohm	MCR10EZPF8202	Yes	Yes
R2, R3	2	Resistor	330 k Ω	1%	0207	Vishay	HVR2500003303FR500	Yes	Yes
R4	1	Resistor Through Hole, High Voltage	4.7 M Ω	5%	Axial Lead	Welwyn	VRW37-4M7JI	Yes	Yes
R5	1	NTC Thermistor	Wire Strap	-	Disc - Radial	-	-	Yes	Yes
R6	1	Surge protecting varistor	B72210P2301-K101	20%	Disc - Radial	Epcos	B72210P2301K101	Yes	Yes

NCP4354AADAPGEVB

Table 3. BILL OF MATERIAL

Designator	QTY	Description	Value	Tolerance	Footprint	Manufacturer	Manufacturer Part Number	Substitution Allowed	Lead Free
R7	1	Resistor	15 Ω	1%	0207	Vishay	MRS25000C1509FRP00	Yes	Yes
TR1	1	Transformer	KA5038-BL	-	KA5038-BL	CoilCraft	KA5037-BL	Yes	Yes
X1	1	Terminal Block, 2 Way	CTB5000/2	-	W237-102	Cadem El.	CTB5000/2	Yes	Yes
X2	1	Terminal Block, 3 Way	CTB5000/3	-	W237-113	Cadem El.	CTB5000/3	Yes	Yes
Q1, D1	2	EMI Suppression Ferrite Bead	742 700 73	-	742 700 73	Würth Elektronik	742 700 73	Yes	Yes
D2	1	Heat Sink Type 1	-	-	-	-	-	Yes	Yes
Q2	1	Heat Sink Type 2	-	-	-	-	-	Yes	Yes
Q1, D2	2	TO220 Transistor In- sul Pad 1.13 x 0.63" & Bushings & Screw	-	-	-	-	TO-220-68	Yes	Yes

NCP4354AADAPGEVB

Evaluation Board Photo

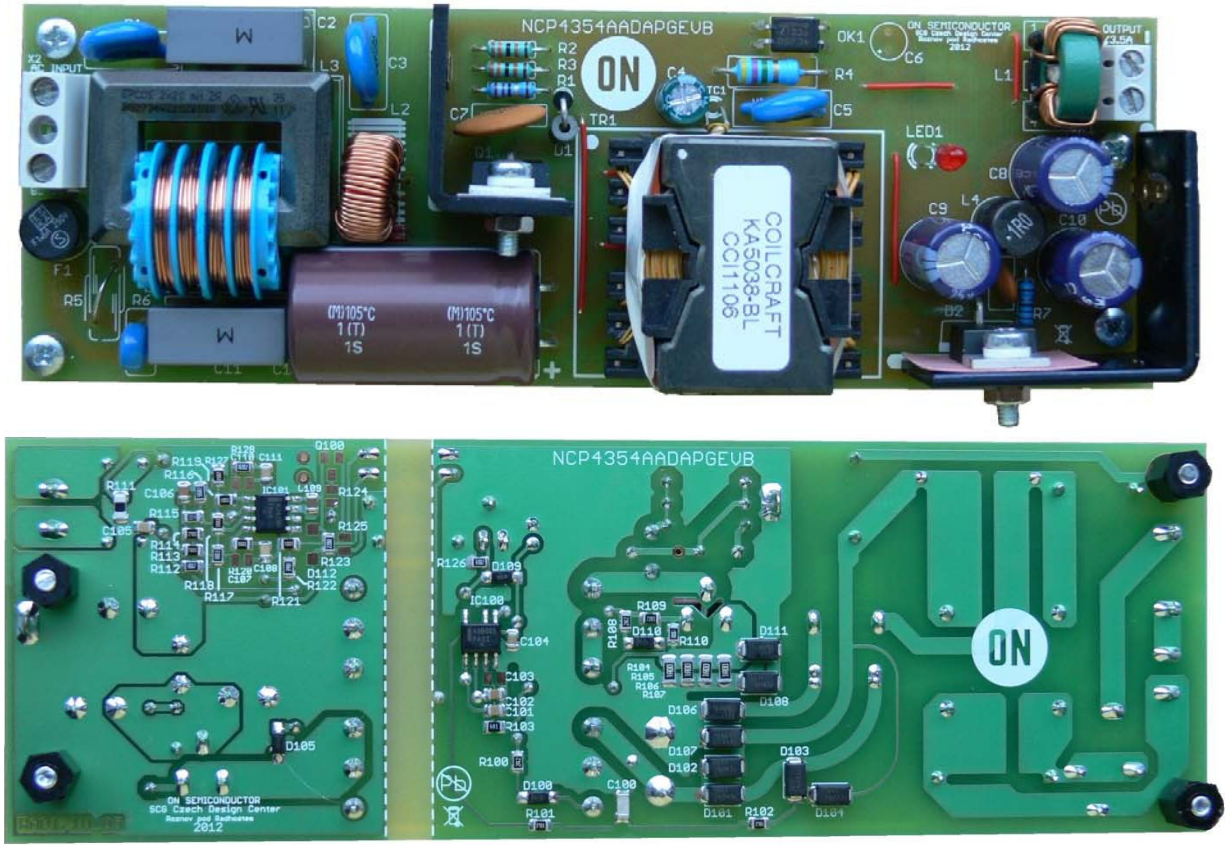

Figure 45. Evaluation Board Photo

onsemi, **Onsemi**, and other names, marks, and brands are registered and/or common law trademarks of Semiconductor Components Industries, LLC dba "**onsemi**" or its affiliates and/or subsidiaries in the United States and/or other countries. **onsemi** owns the rights to a number of patents, trademarks, copyrights, trade secrets, and other intellectual property. A listing of **onsemi**'s product/patent coverage may be accessed at www.onsemi.com/site/pdf/Patent-Marking.pdf. **onsemi** is an Equal Opportunity/Affirmative Action Employer. This literature is subject to all applicable copyright laws and is not for resale in any manner.

The evaluation board/kit (research and development board/kit) (hereinafter the "board") is not a finished product and is not available for sale to consumers. The board is only intended for research, development, demonstration and evaluation purposes and will only be used in laboratory/development areas by persons with an engineering/technical training and familiar with the risks associated with handling electrical/mechanical components, systems and subsystems. This person assumes full responsibility/liability for proper and safe handling. Any other use, resale or redistribution for any other purpose is strictly prohibited.

THE BOARD IS PROVIDED BY ONSEMI TO YOU "AS IS" AND WITHOUT ANY REPRESENTATIONS OR WARRANTIES WHATSOEVER. WITHOUT LIMITING THE FOREGOING, ONSEMI (AND ITS LICENSORS/SUPPLIERS) HEREBY DISCLAIMS ANY AND ALL REPRESENTATIONS AND WARRANTIES IN RELATION TO THE BOARD, ANY MODIFICATIONS, OR THIS AGREEMENT, WHETHER EXPRESS, IMPLIED, STATUTORY OR OTHERWISE, INCLUDING WITHOUT LIMITATION ANY AND ALL REPRESENTATIONS AND WARRANTIES OF MERCHANTABILITY, FITNESS FOR A PARTICULAR PURPOSE, TITLE, NON-INFRINGEMENT, AND THOSE ARISING FROM A COURSE OF DEALING, TRADE USAGE, TRADE CUSTOM OR TRADE PRACTICE.

onsemi reserves the right to make changes without further notice to any board.

You are responsible for determining whether the board will be suitable for your intended use or application or will achieve your intended results. Prior to using or distributing any systems that have been evaluated, designed or tested using the board, you agree to test and validate your design to confirm the functionality for your application. Any technical, applications or design information or advice, quality characterization, reliability data or other services provided by **onsemi** shall not constitute any representation or warranty by **onsemi**, and no additional obligations or liabilities shall arise from **onsemi** having provided such information or services.

onsemi products including the boards are not designed, intended, or authorized for use in life support systems, or any FDA Class 3 medical devices or medical devices with a similar or equivalent classification in a foreign jurisdiction, or any devices intended for implantation in the human body. You agree to indemnify, defend and hold harmless **onsemi**, its directors, officers, employees, representatives, agents, subsidiaries, affiliates, distributors, and assigns, against any and all liabilities, losses, costs, damages, judgments, and expenses, arising out of any claim, demand, investigation, lawsuit, regulatory action or cause of action arising out of or associated with any unauthorized use, even if such claim alleges that **onsemi** was negligent regarding the design or manufacture of any products and/or the board.

This evaluation board/kit does not fall within the scope of the European Union directives regarding electromagnetic compatibility, restricted substances (RoHS), recycling (WEEE), FCC, CE or UL, and may not meet the technical requirements of these or other related directives.

FCC WARNING – This evaluation board/kit is intended for use for engineering development, demonstration, or evaluation purposes only and is not considered by **onsemi** to be a finished end product fit for general consumer use. It may generate, use, or radiate radio frequency energy and has not been tested for compliance with the limits of computing devices pursuant to part 15 of FCC rules, which are designed to provide reasonable protection against radio frequency interference. Operation of this equipment may cause interference with radio communications, in which case the user shall be responsible, at its expense, to take whatever measures may be required to correct this interference.

onsemi does not convey any license under its patent rights nor the rights of others.

LIMITATIONS OF LIABILITY: **onsemi** shall not be liable for any special, consequential, incidental, indirect or punitive damages, including, but not limited to the costs of requalification, delay, loss of profits or goodwill, arising out of or in connection with the board, even if **onsemi** is advised of the possibility of such damages. In no event shall **onsemi**'s aggregate liability from any obligation arising out of or in connection with the board, under any theory of liability, exceed the purchase price paid for the board, if any.

The board is provided to you subject to the license and other terms per **onsemi**'s standard terms and conditions of sale. For more information and documentation, please visit www.onsemi.com.

PUBLICATION ORDERING INFORMATION

LITERATURE FULFILLMENT:

Email Requests to: orderlit@onsemi.com

onsemi Website: www.onsemi.com

TECHNICAL SUPPORT

North American Technical Support:

Voice Mail: 1 800-282-9855 Toll Free USA/Canada

Phone: 011 421 33 790 2910

Europe, Middle East and Africa Technical Support:

Phone: 00421 33 790 2910

For additional information, please contact your local Sales Representative