

## **NCP1568 USB-PD Evaluation Board User's Manual**



**ON Semiconductor®**

[www.onsemi.com](http://www.onsemi.com)

### **EVAl BOARD USER'S MANUAL**

#### **Circuit Description**

This evaluation board manual describes a 60 W universal input 5 V, 9 V, 12 V, 15 V and 20 V output evaluation board for laptop adapters. This featured power supply is an active-clamp flyback topology utilizing ON Semiconductor NCP1568 PWM controller, NCP51530 HB Driver, NCP4305 SR Controller and FDMS86202 SR FET. This manual provides complete circuit schematic, PCB, BOM and transformer information of the evaluation board. It also provide efficiency, transient response, output ripple and thermal data of the evaluation board.

This design utilized NCP1568 and NCP51530 for the active clamp flyback topology. Active clamp flyback topology effectively recycles the leakage energy. Another feature of this topology is the ZVS operation of the power MOSFETS. Because of no leakage losses and ZVS operation, this topology is suited for high frequency operation which results in size reduction of the transformer. Hence Active clamp flyback topology is well suited for high power density sub 100 W power supplies. A ZVS fixed switching frequency power converter also simplifies EMI design and can be easily designed to avoid interference with other sensitive circuits in the system.

#### **Key Features**

- Universal AC Input Operation (90 – 265 Vac)
- High Full Load and Average Efficiency
- Low Standby Power
- Very Low Ripple and Noise
- High Frequency Operation up to 450 kHz
- Inherent SCP and OCP Protection
- Thermal and OVP Protection
- Adaptive Frequency Operation based on AC Input and Output Load Conditions
- Adaptive ZVS Operation
- Smaller EMI Components
- Multiple Probe Points for Evaluation
- Smooth Startup Operation

<b>Specifications</b>	
Output Voltage	5, 9, 12, 15, 20 V
Ripple	1 V
Nominal Current	3 A
Max Current	3 A
Min Current	Zero

<b>Device</b>	<b>Application</b>	<b>Input Voltage</b>	<b>Output Power</b>	<b>Topology</b>	<b>I/O Isolation</b>
NCP1568 NCP51530 NCP4305 NCP4328 FDMS86202	USBPD Laptop Adapter	90 Vac to 265 Vdc	60 W	Active Clamp Flyback	Isolated (3 kV)

NOTE: This board is intended to emulate the output voltages of USB-PD through manual interaction. This board should not be used as a charging device for any USB-PD compatible device.

# EVBUM2734/D

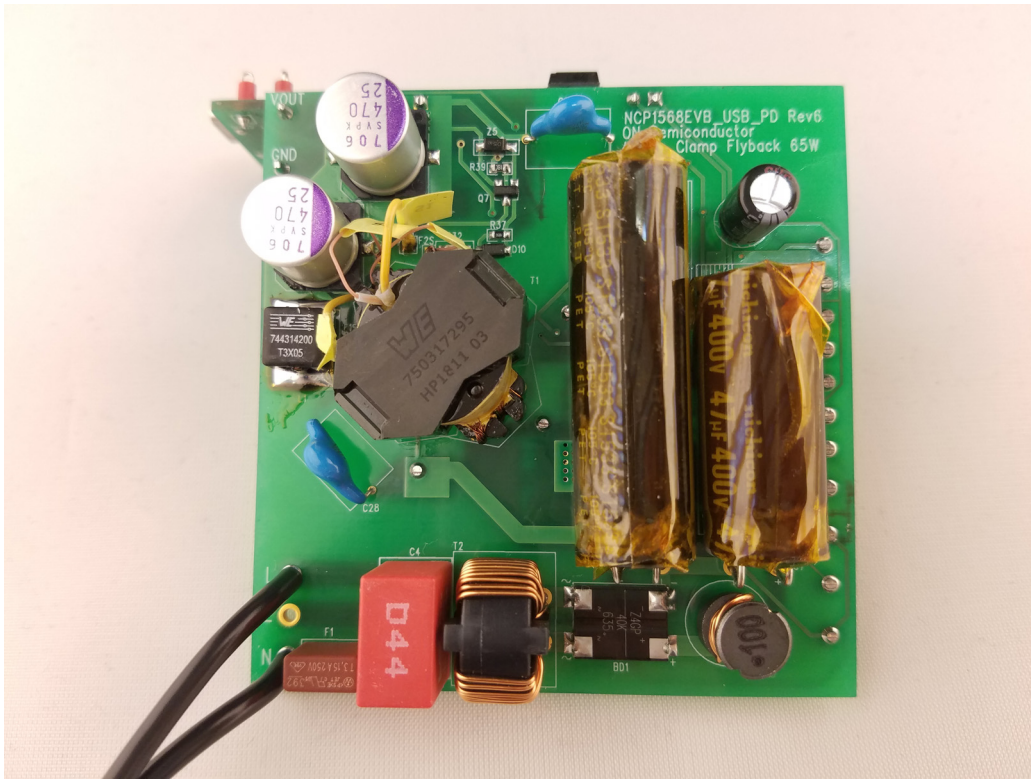

Figure 1. Top View of the Evaluation Board

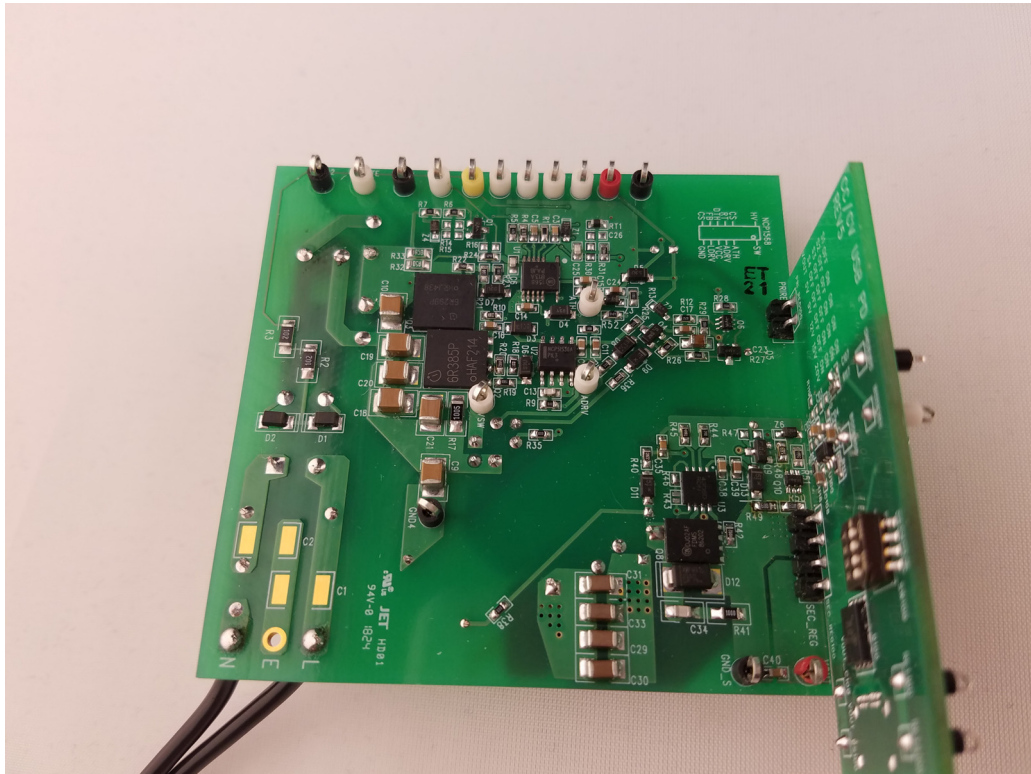

Figure 2. Bottom View of the Evaluation Board

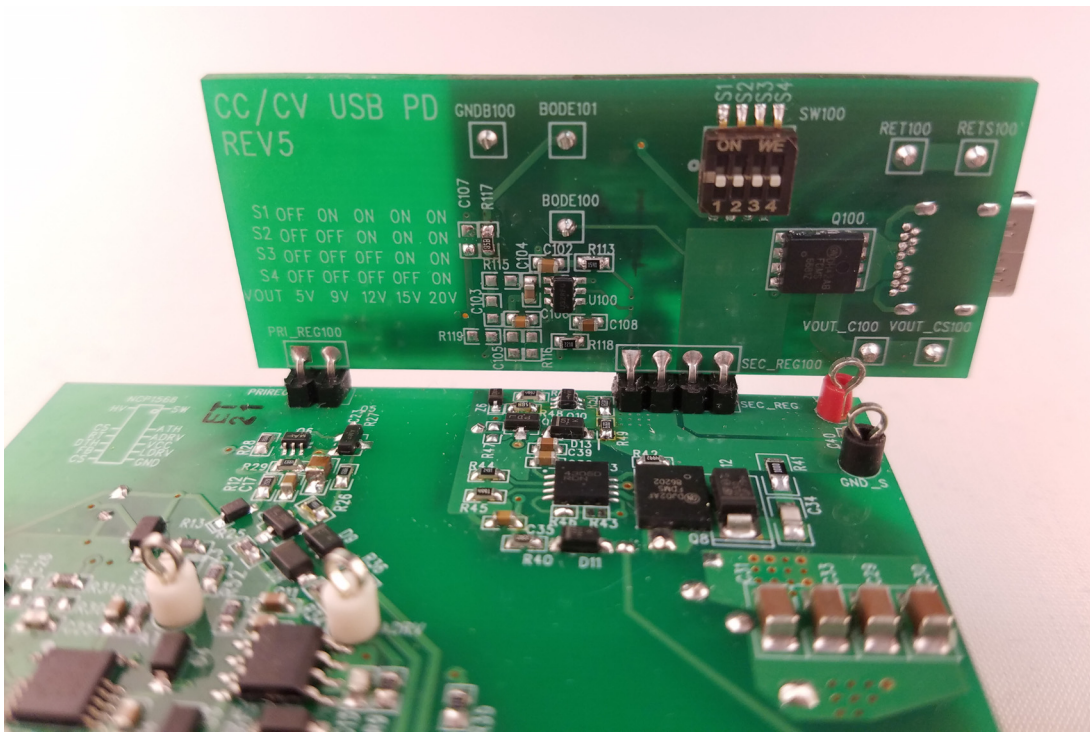

Figure 3. Bottom View of the Daughter Card

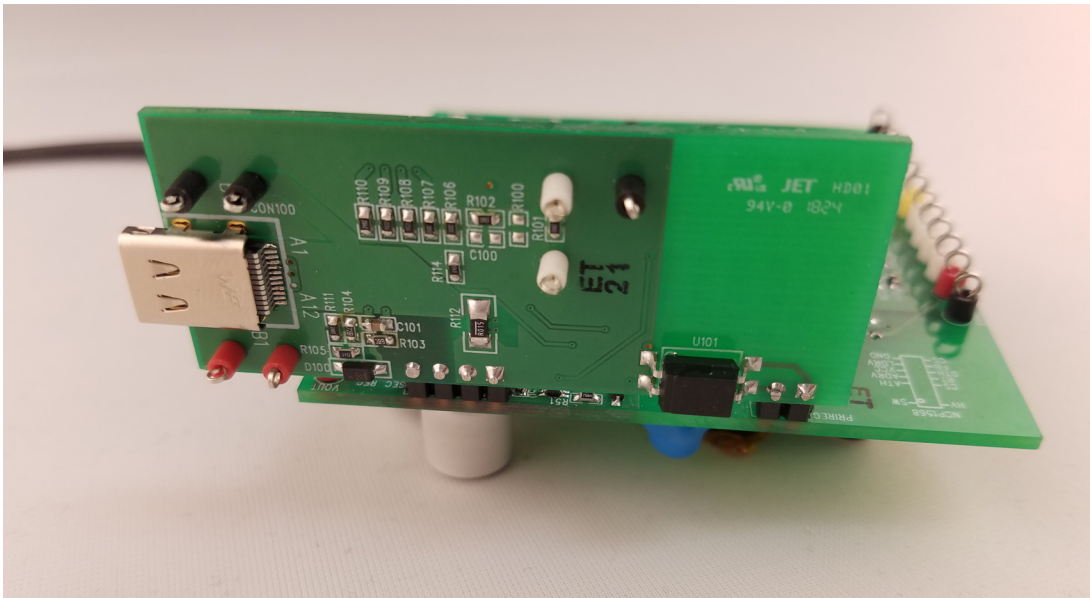

Figure 4. Top View of the Daughter Card

MAIN BOARD LAYOUT

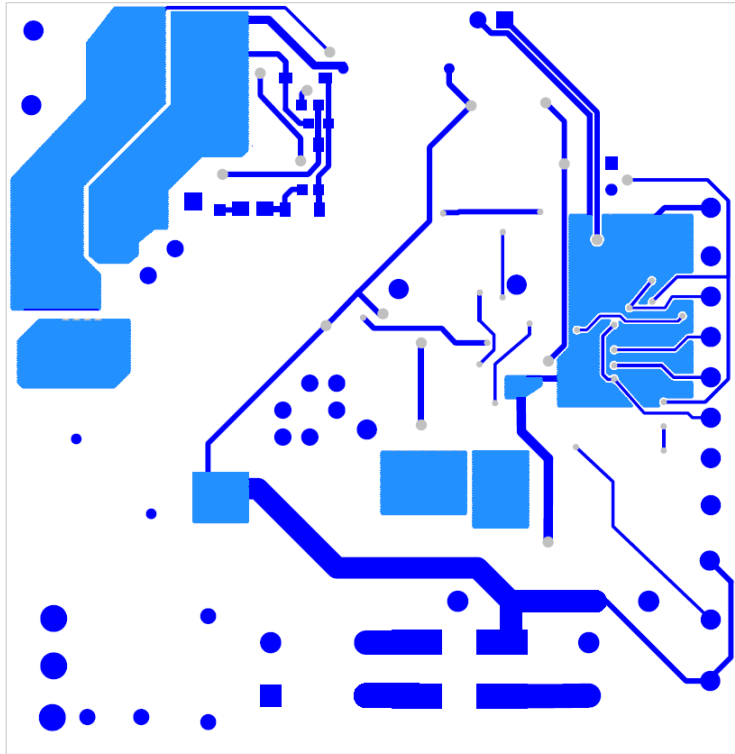

Figure 5. Top Layer

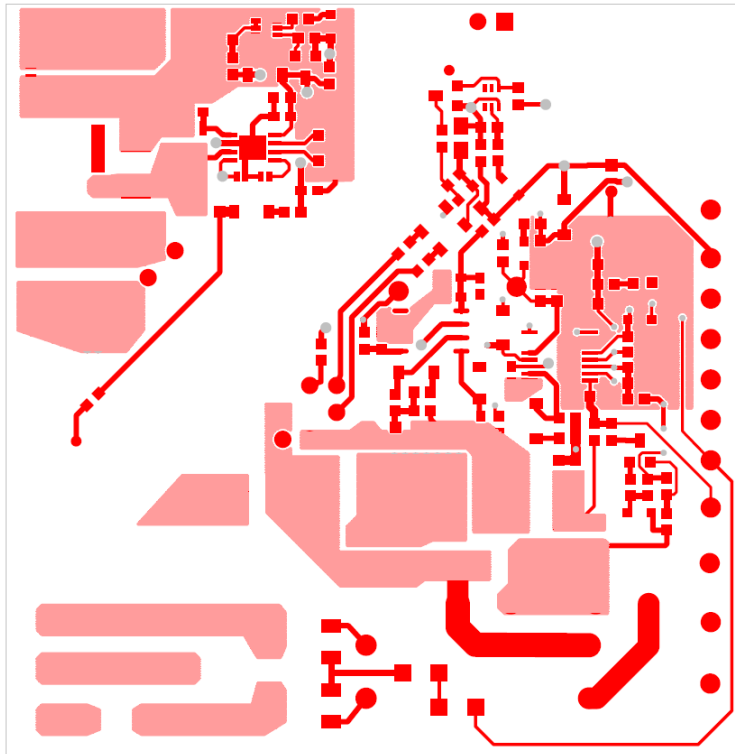

Figure 6. Bottom Layer

DAUGHTER BOARD LAYOUT

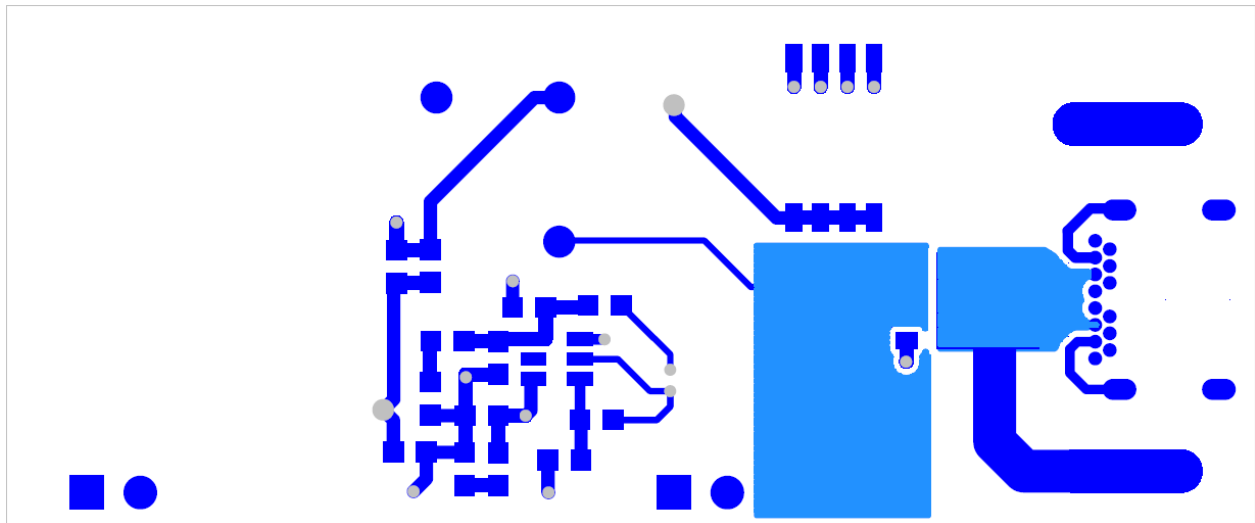

Figure 7. Top Layer

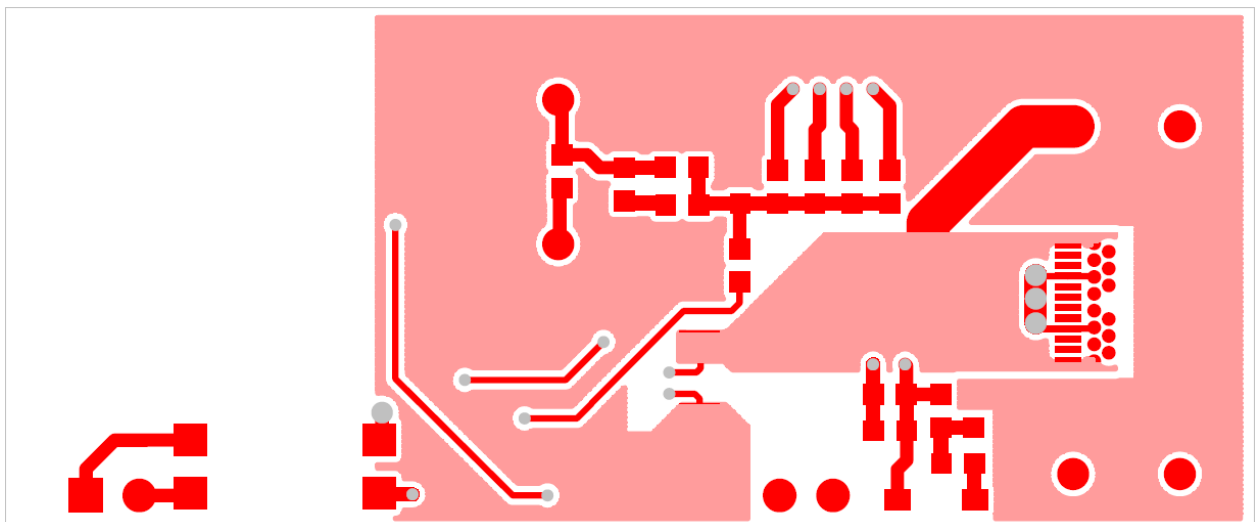

Figure 8. Bottom Layer

MAIN BOARD SCHEMATIC

Note: For detailed version, see separate [Schematic PDF](#)

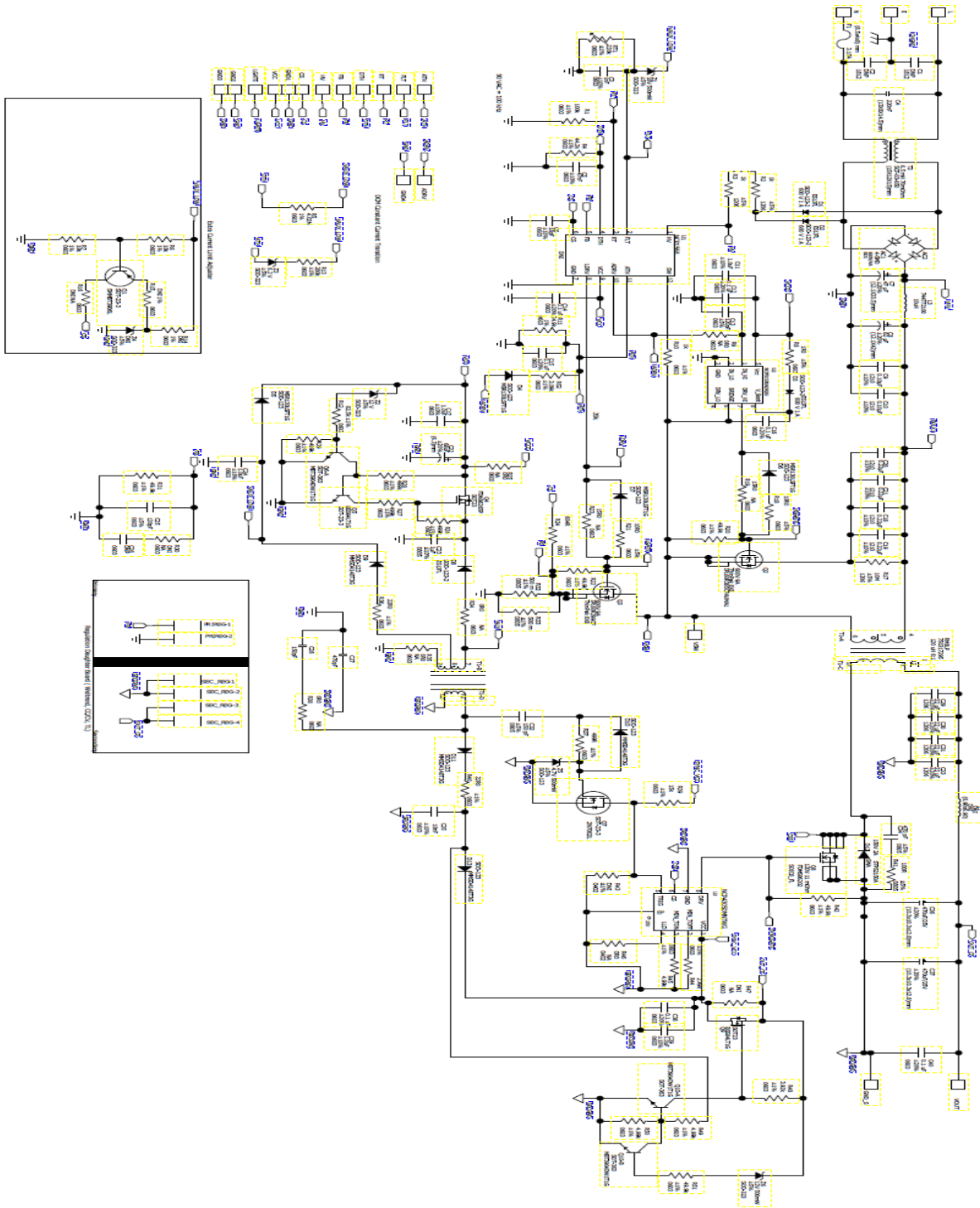

Figure 9. Main Board Schematic

DAUGHTER BOARD SCHEMATIC

Note: For detailed version, see separate [Schematic PDF](#)

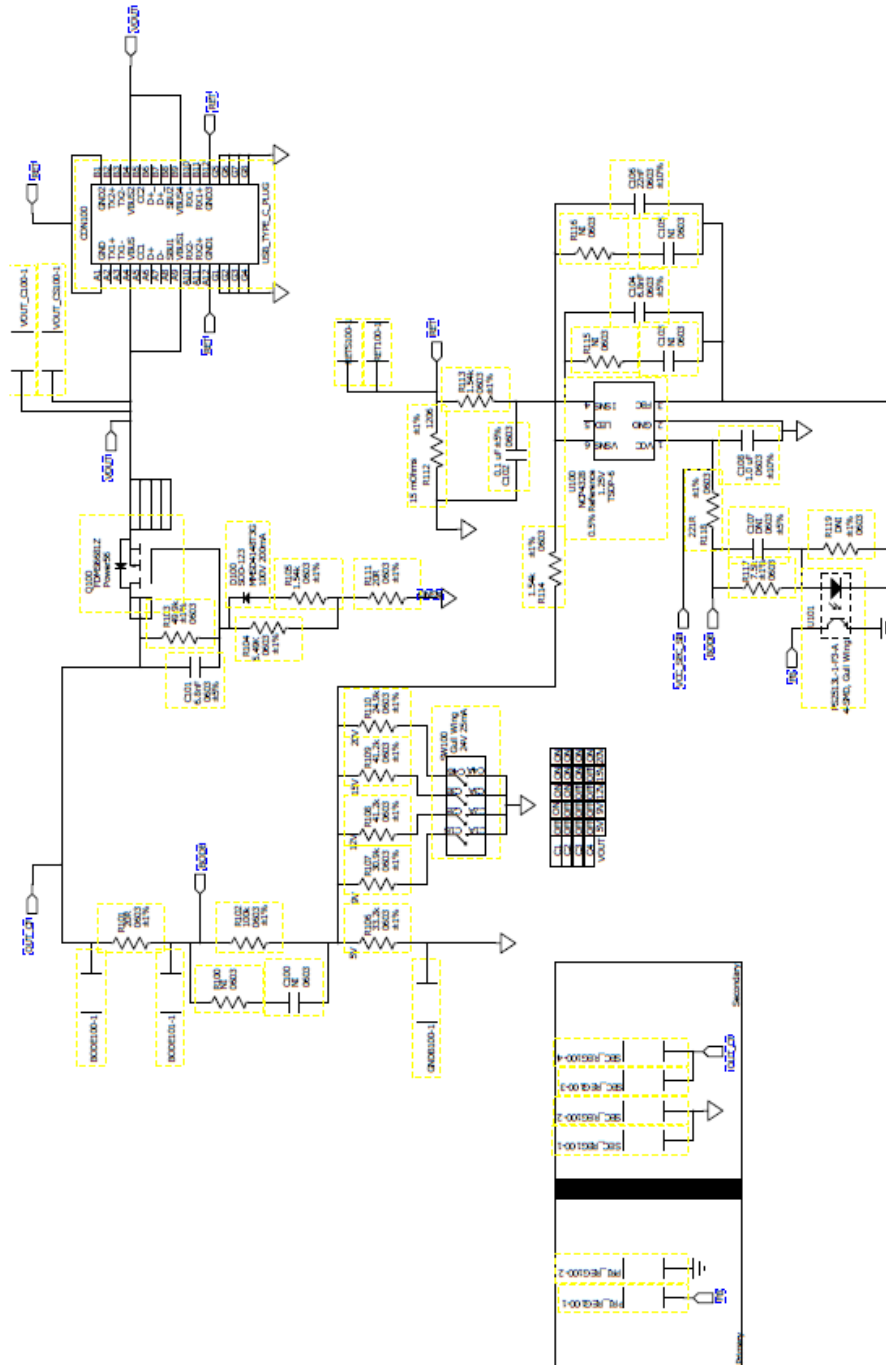

Figure 10. Daughter Board Schematic

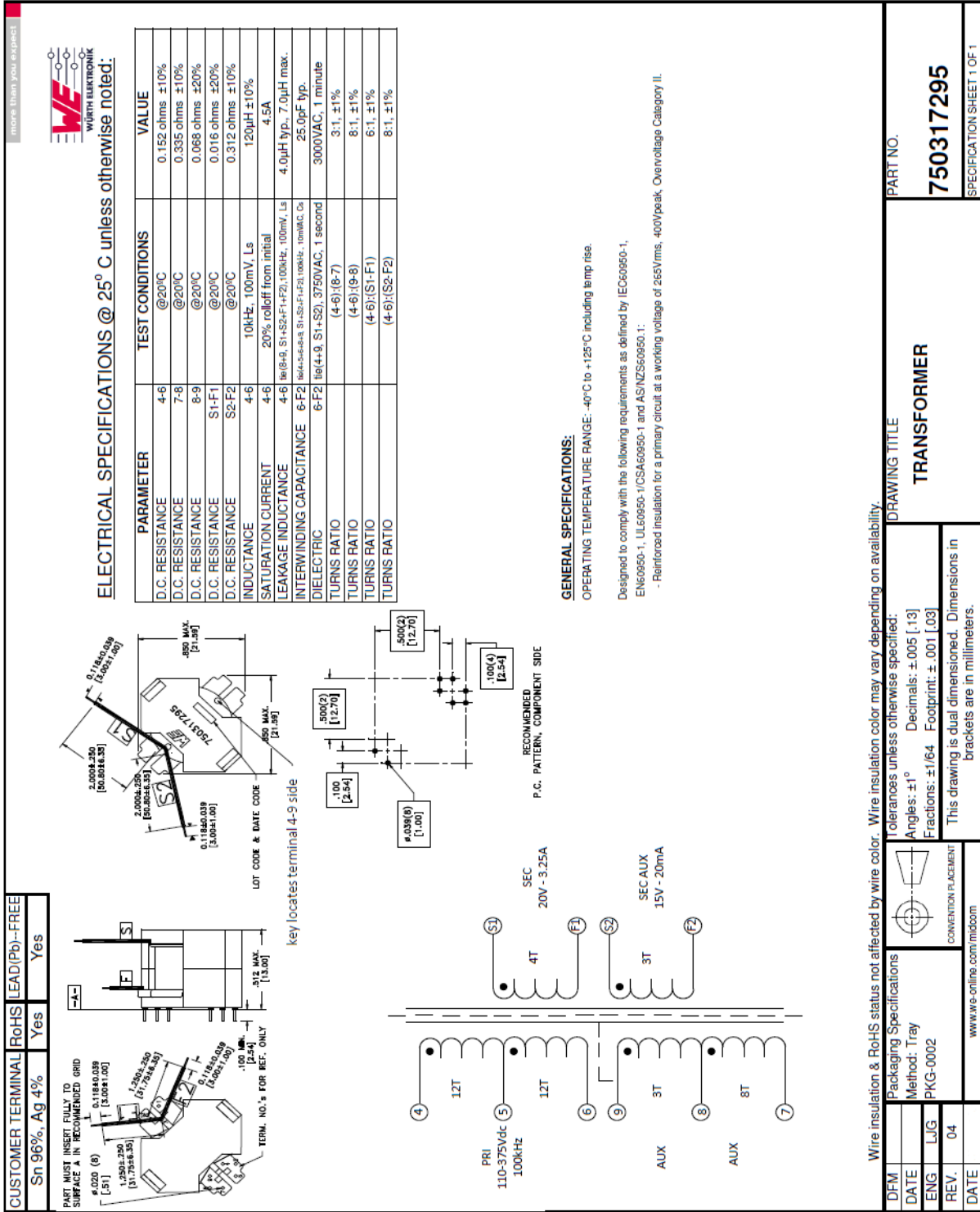

Figure 11. Magnetic Design



Evaluation Board Efficiency Data

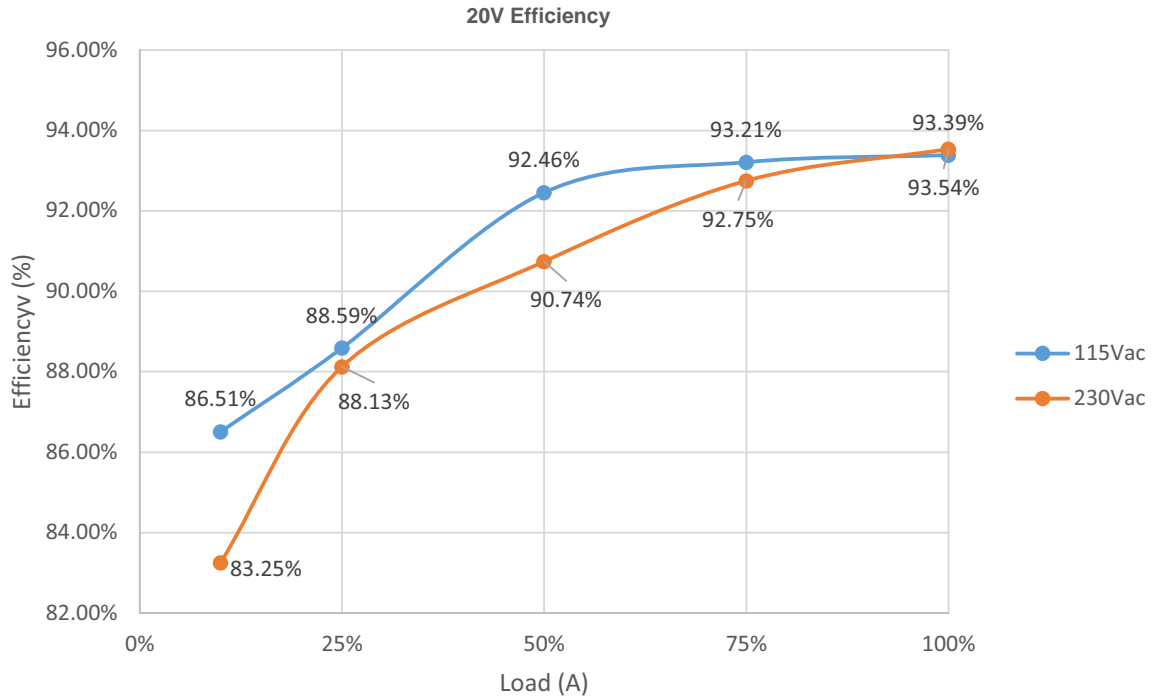

Figure 12. 20 V Efficiency

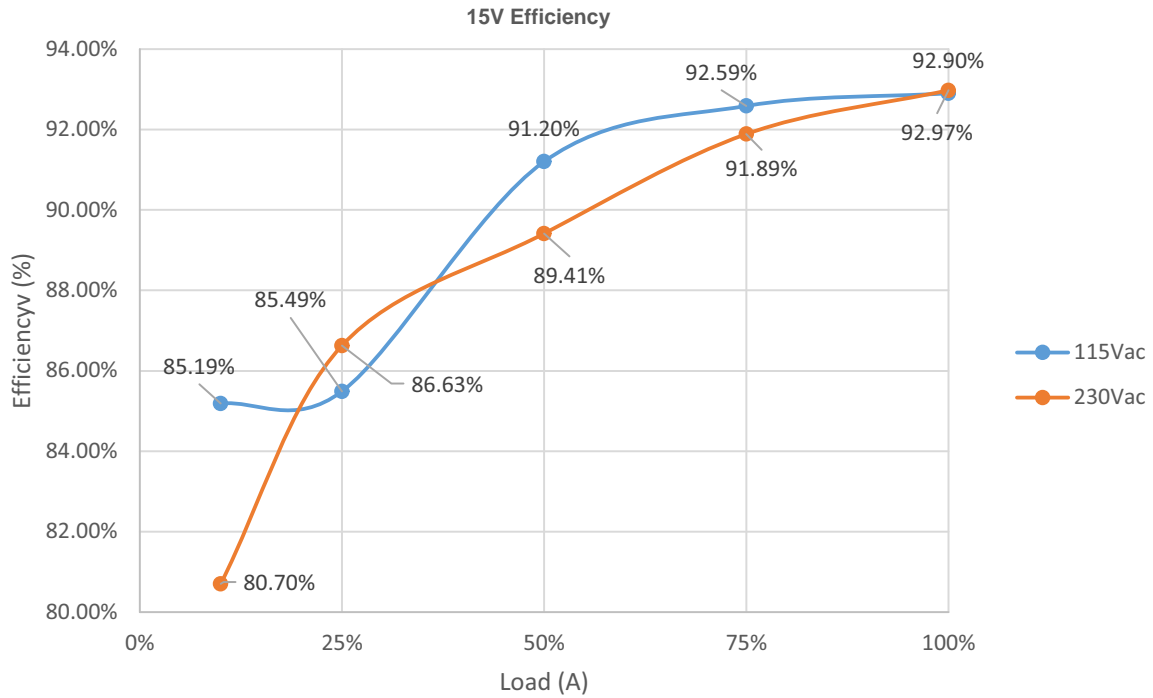

Figure 13. 15 V Efficiency

# EVBUM2734/D

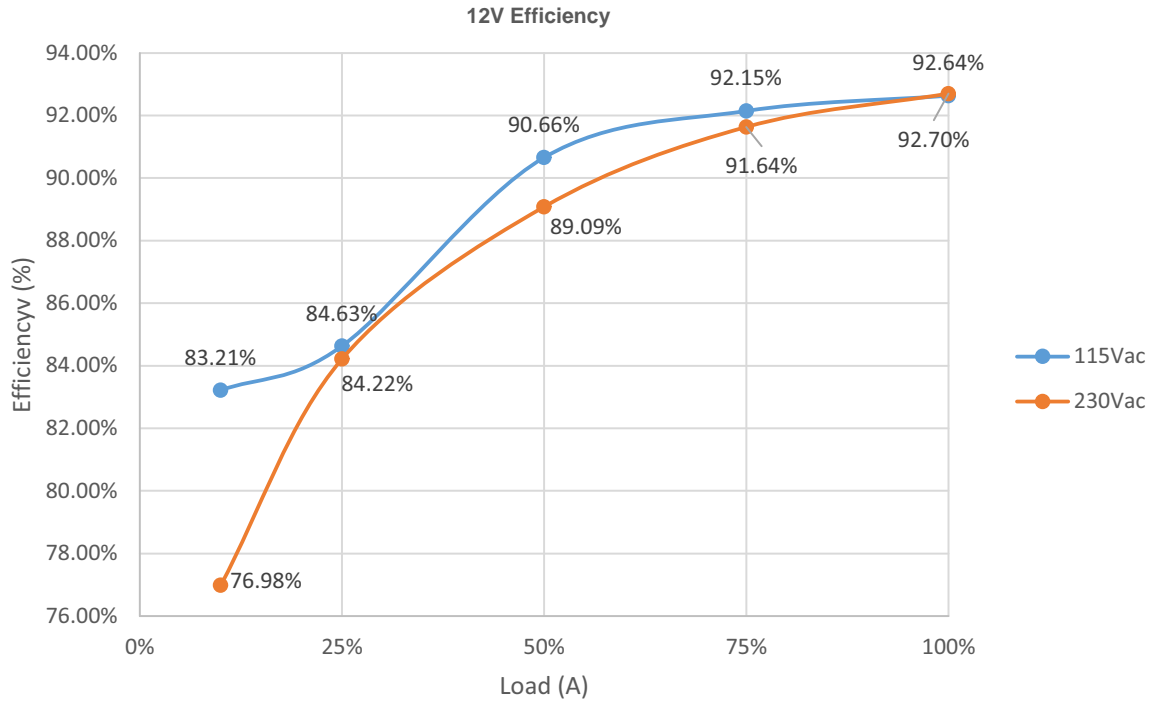

Figure 14. 12 V Efficiency

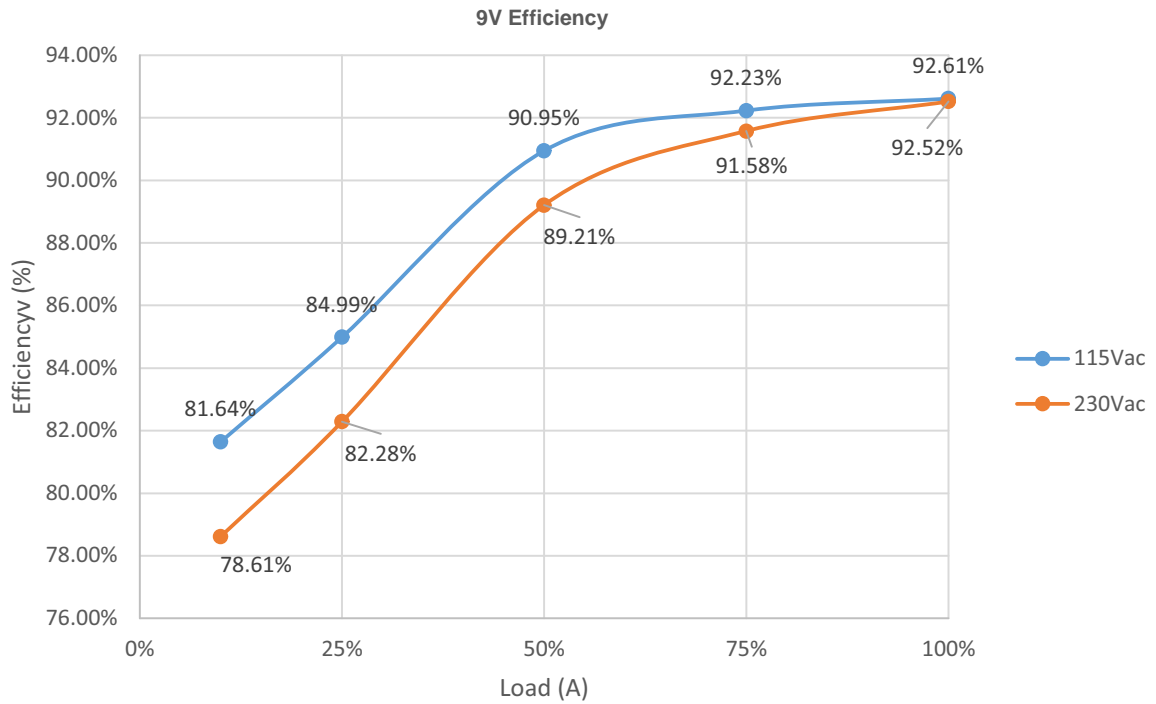

Figure 15. 9 V Efficiency

# EVBUM2734/D

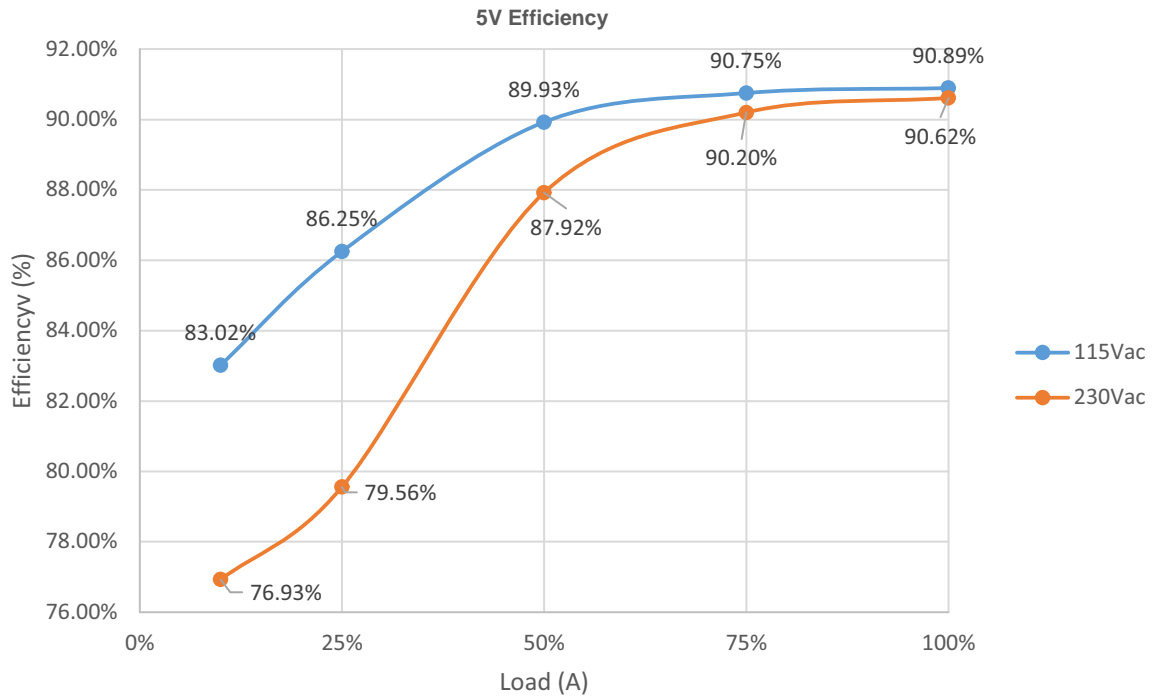

Figure 16. 5 V Efficiency

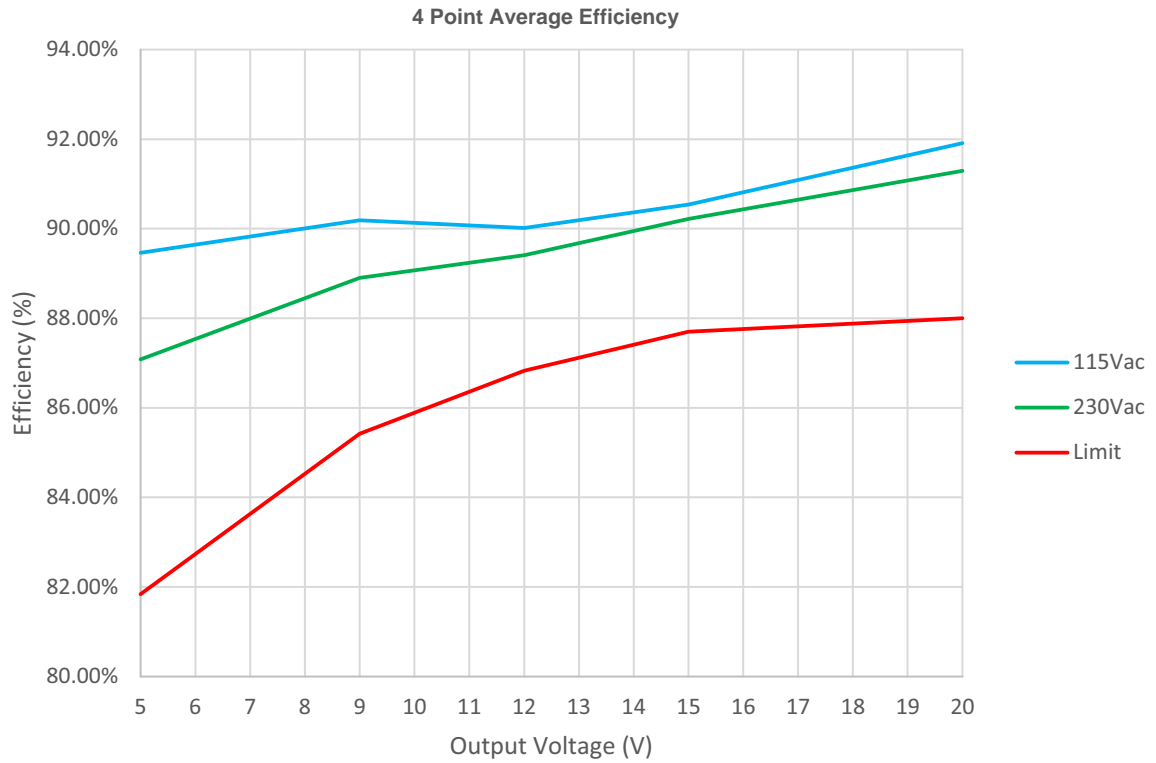

Figure 17. 4-Point Average Efficiency

Waveforms

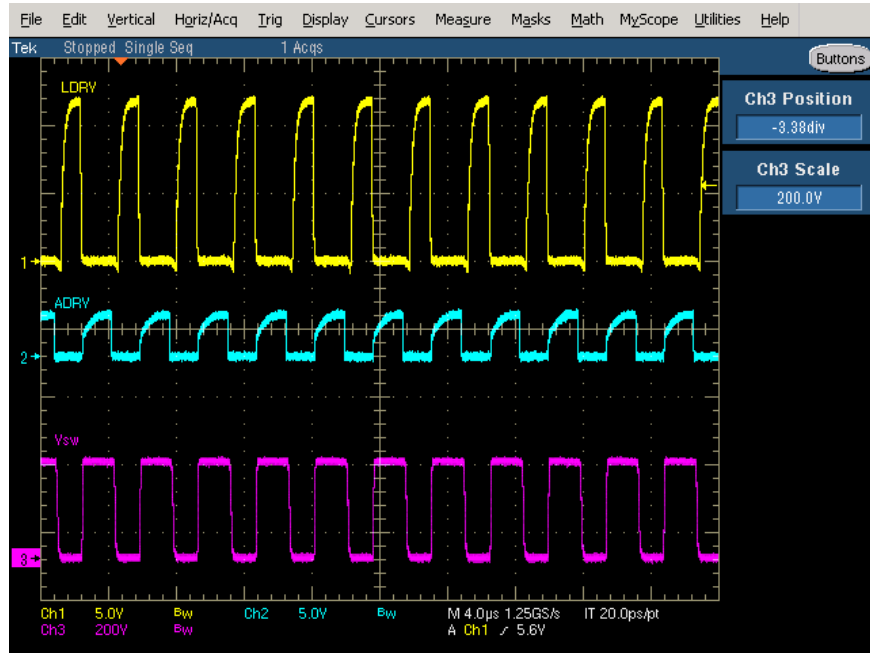

Figure 18. Steady State ACF Operation

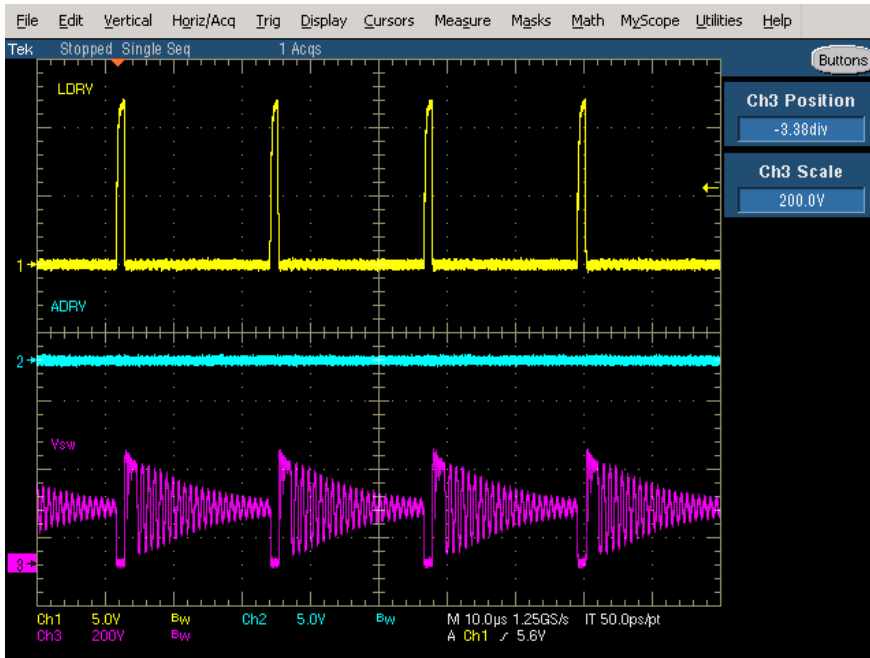

Figure 19. Steady State DCM Operation

# EVBUM2734/D

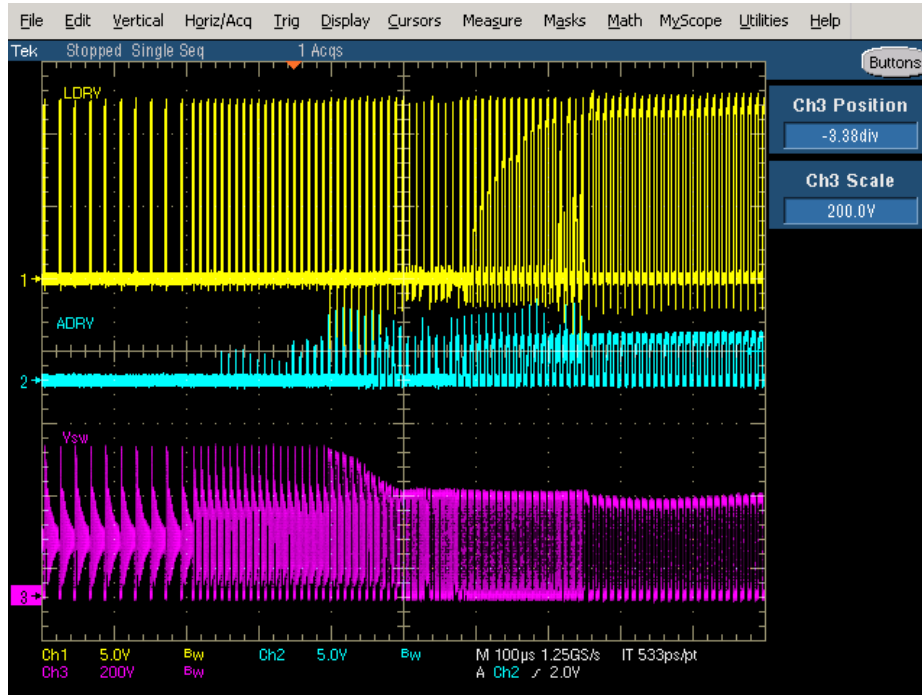

Figure 20. DCM to ACF Transition

Full Load Startup

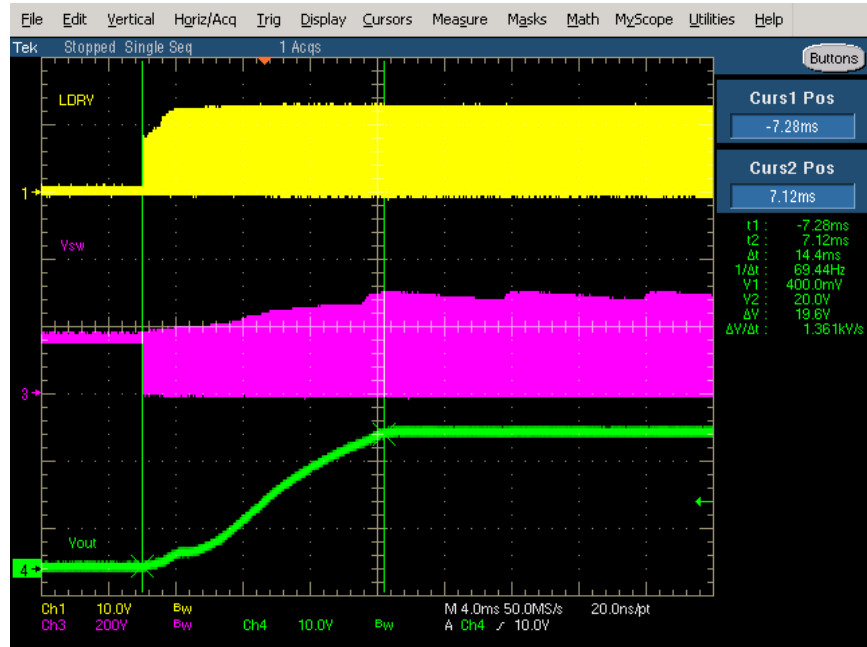

Figure 21. 115 Vac Input, 20 V Output – Full Load Startup Waveform

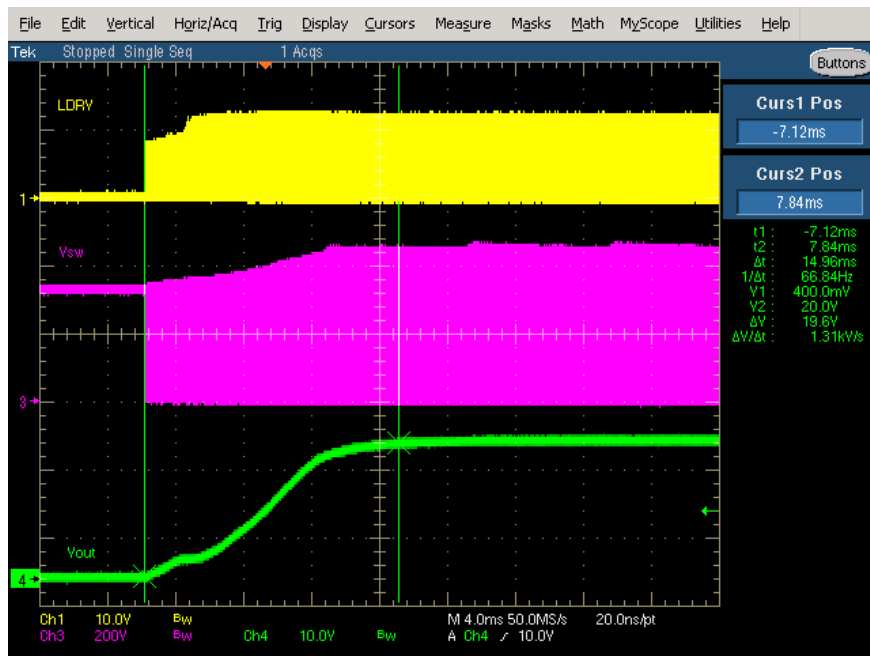

Figure 22. 230 Vac Input, 20 V Output – Full Load Startup Waveform

Output Ripple

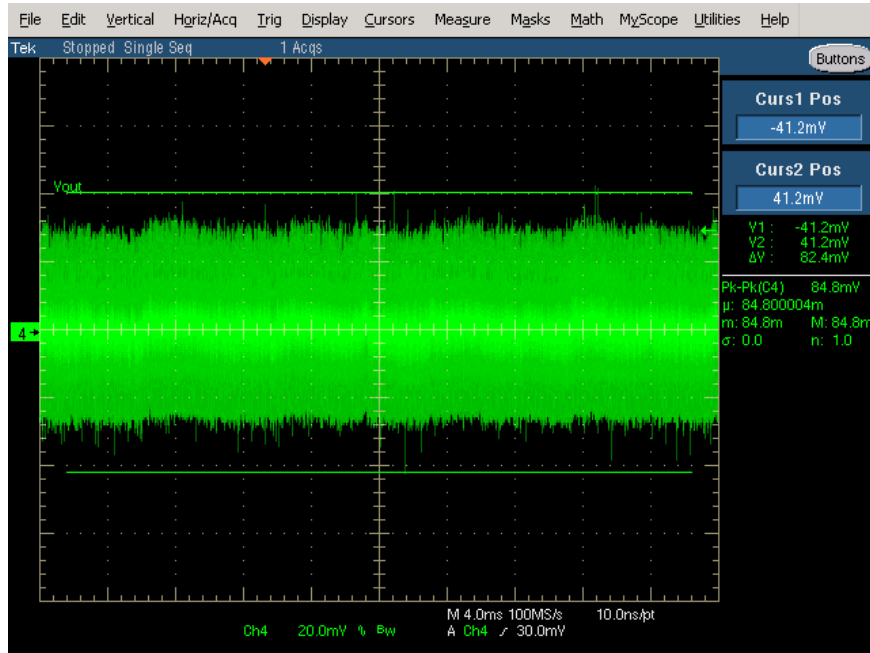

Figure 23. 115 Vac 5 Vout Ripple

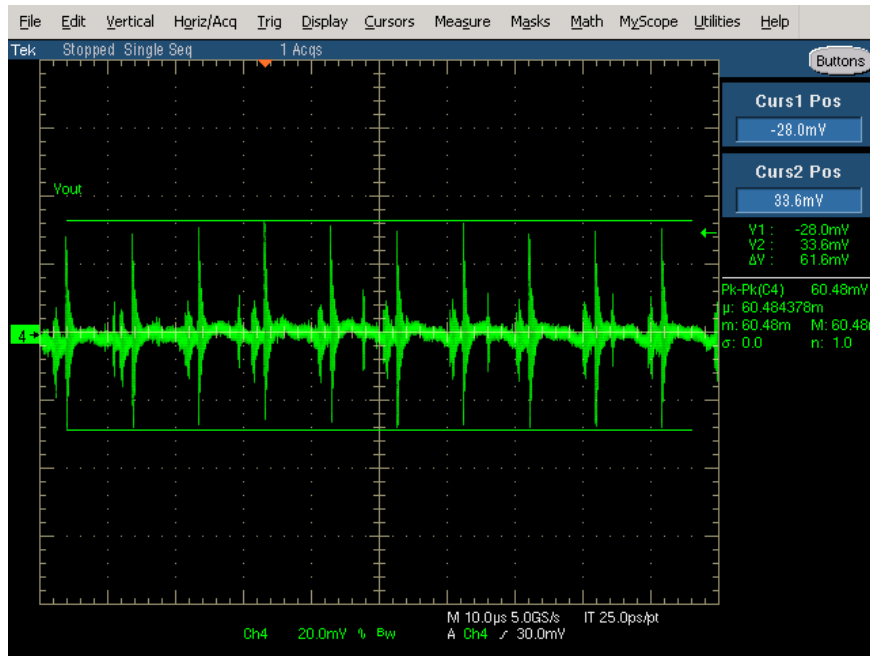

Figure 24. 115 Vac 5 Vout Ripple Zoom

# EVBUM2734/D

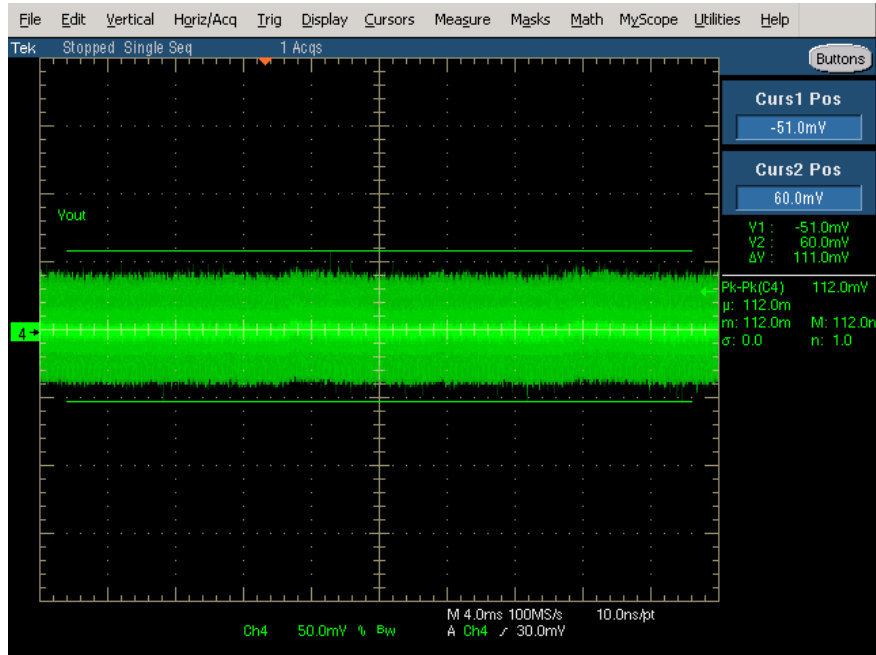

Figure 25. 230 Vac 5 Vout Ripple

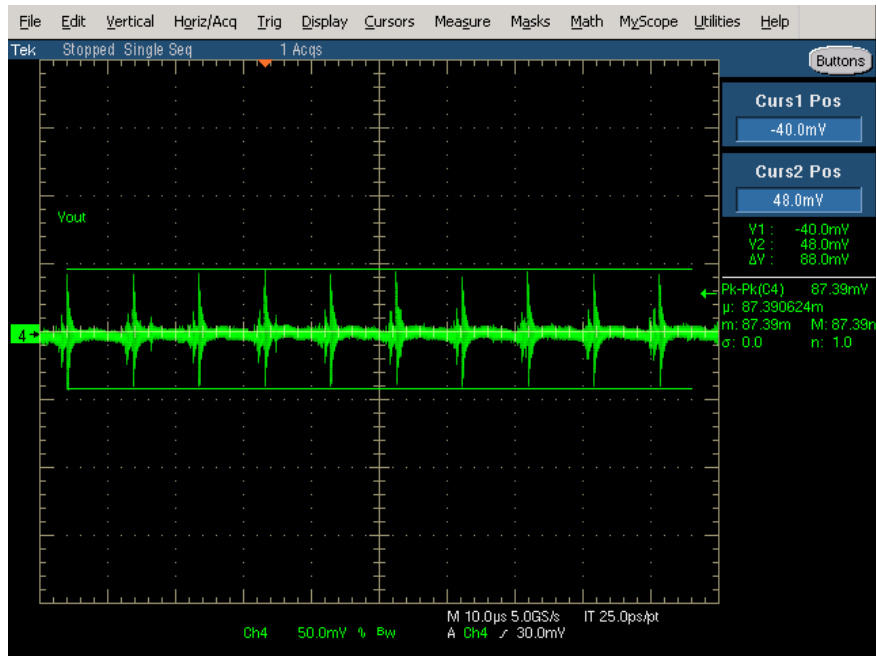

Figure 26. 230 Vac 5 Vout Ripple Zoom



# EVBUM2734/D

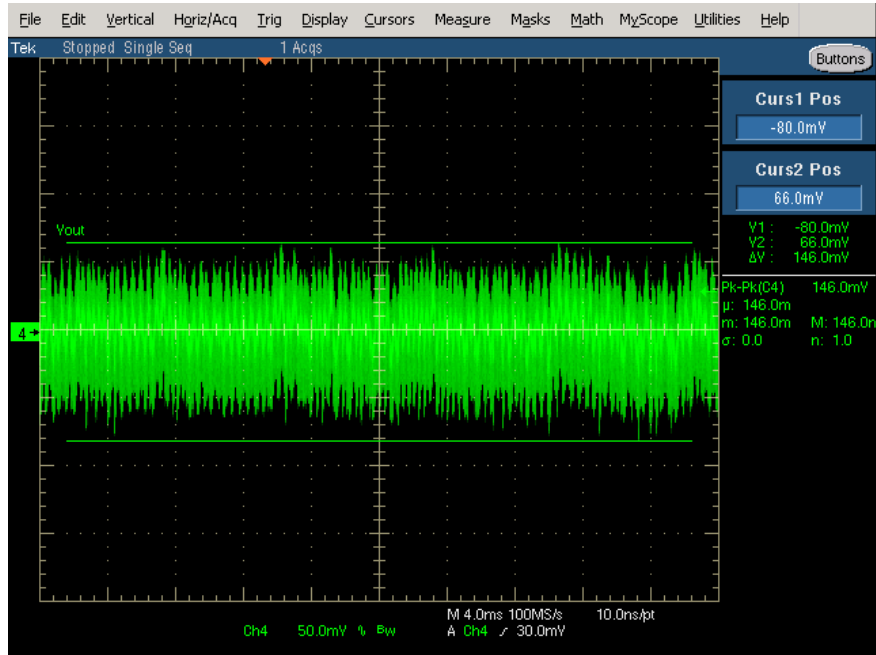

Figure 27. 115 Vac 9 Vout Ripple

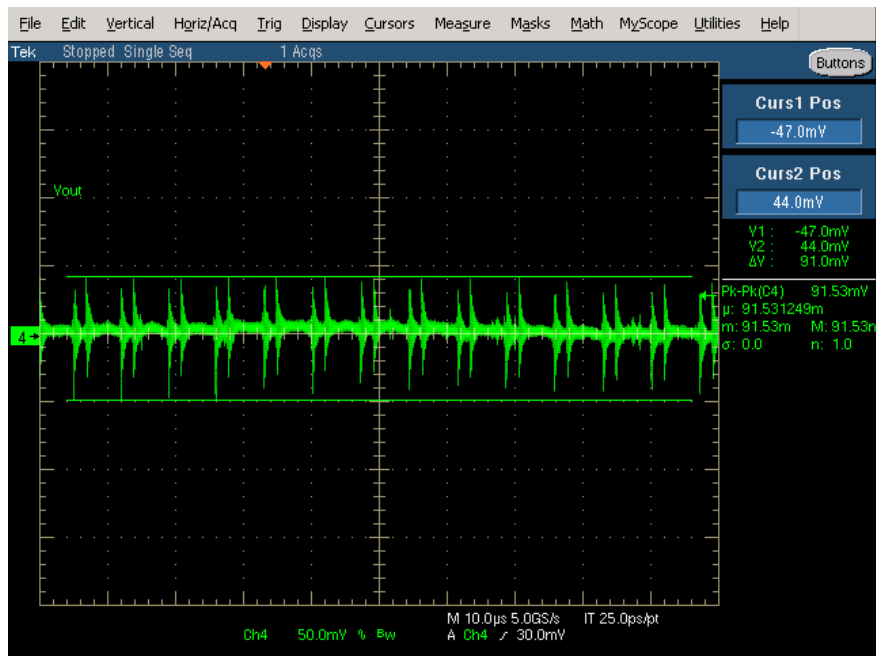

Figure 28. 115 Vac 9 Vout Ripple Zoom

# EVBUM2734/D

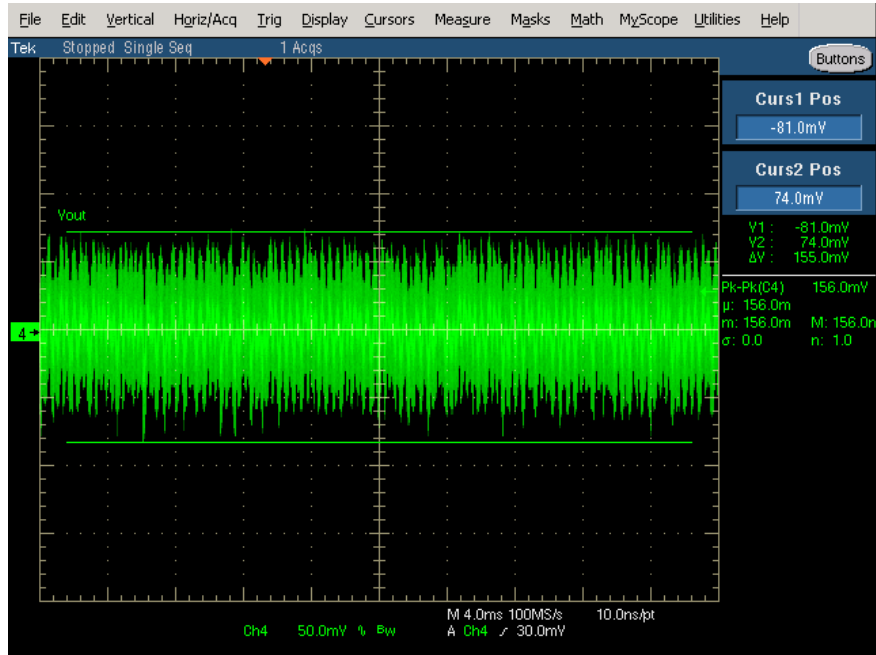

Figure 29. 230 Vac 9 Vout Ripple

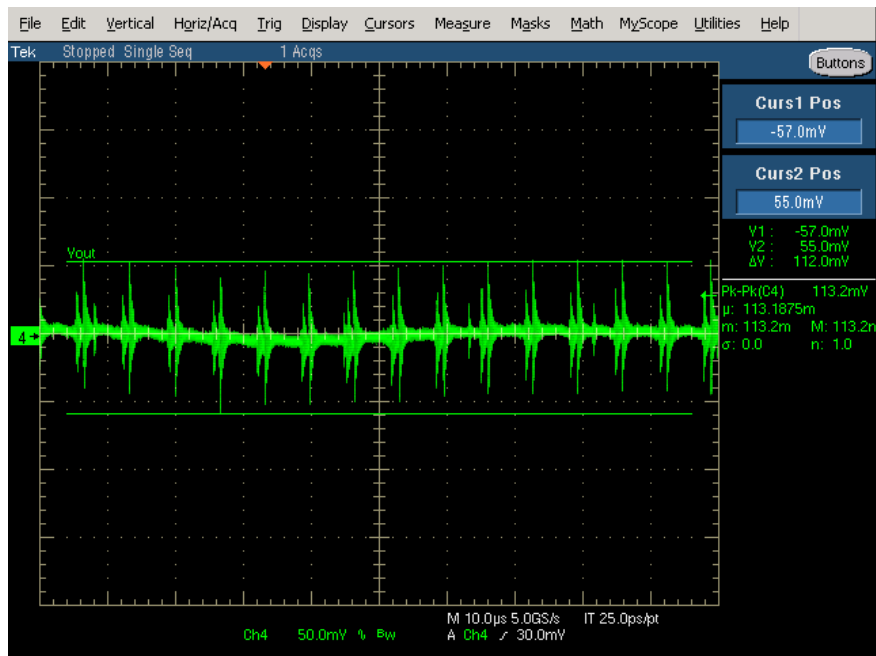

Figure 30. 230 Vac 9 Vout Ripple Zoom

# EVBUM2734/D

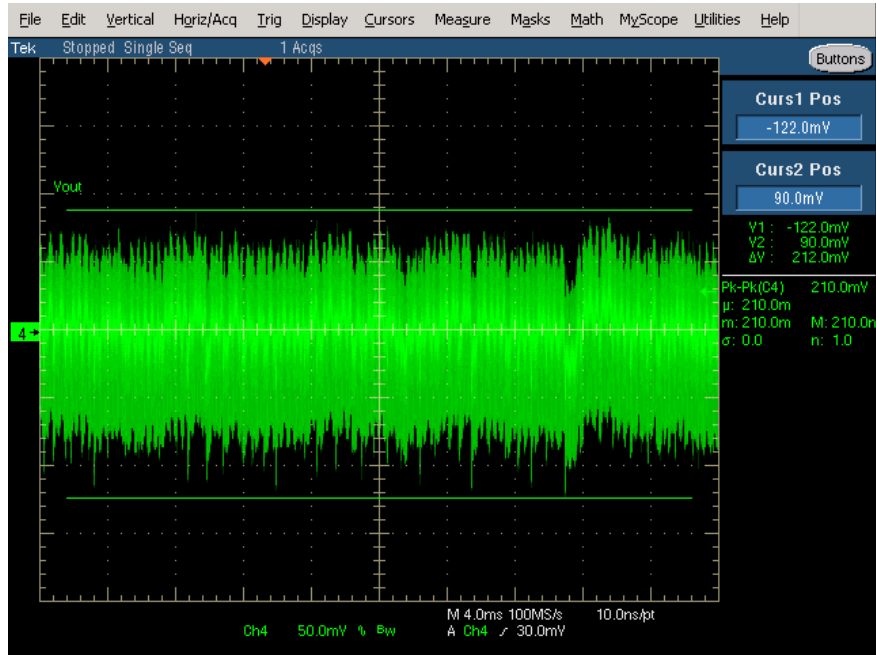

Figure 31. 115 Vac 12 Vout Ripple

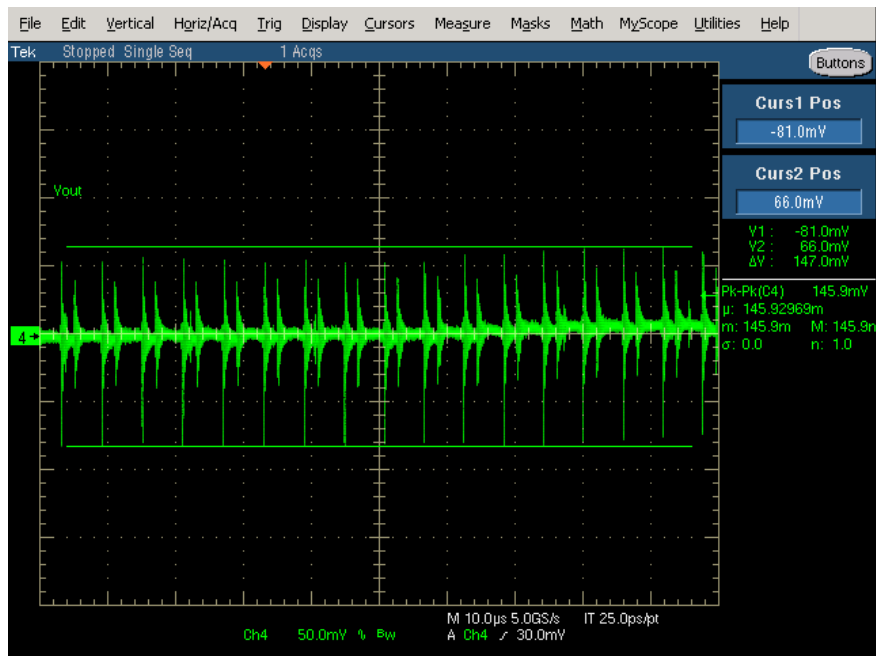

Figure 32. 115 Vac 12 Vout Ripple Zoom

# EVBUM2734/D

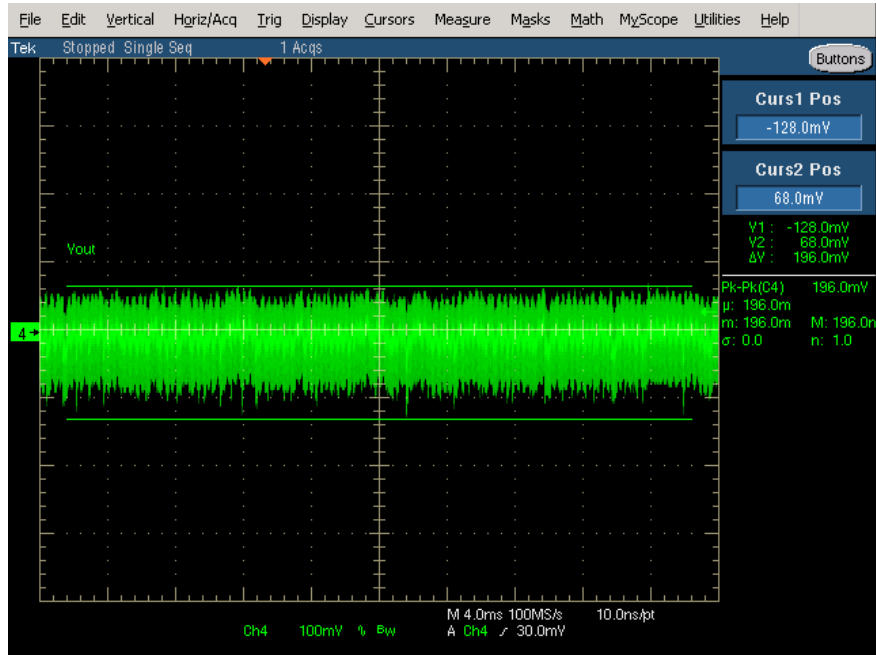

Figure 33. 230 Vac 12 Vout Ripple

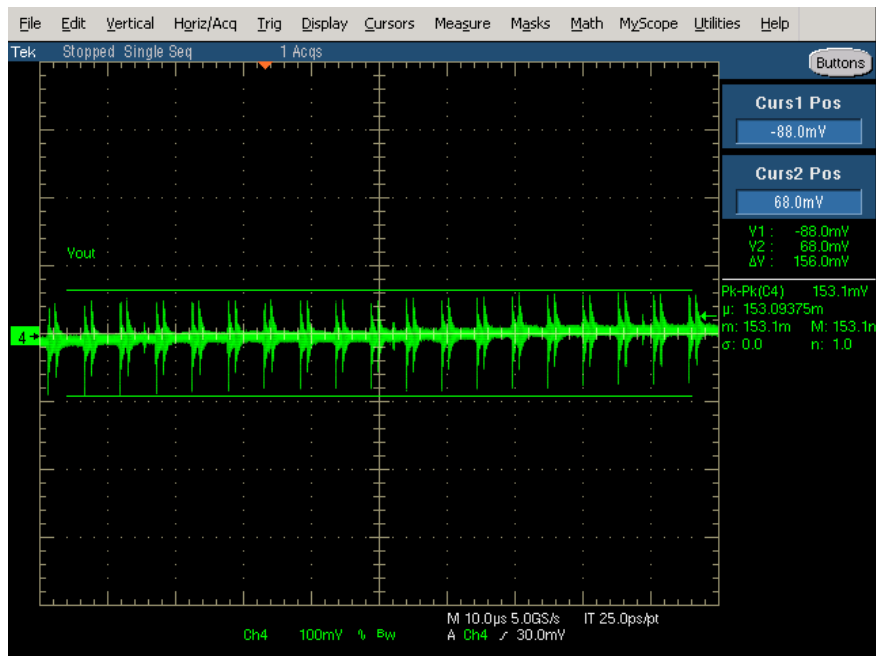

Figure 34. 230 Vac 12 Vout Ripple Zoom

# EVBUM2734/D

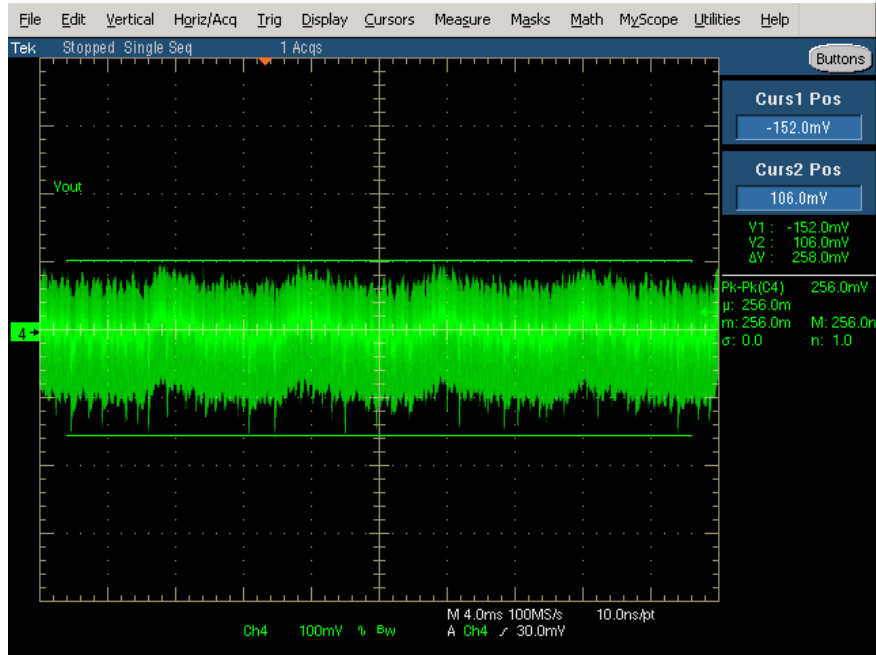

Figure 35. 115 Vac 15 Vout Ripple

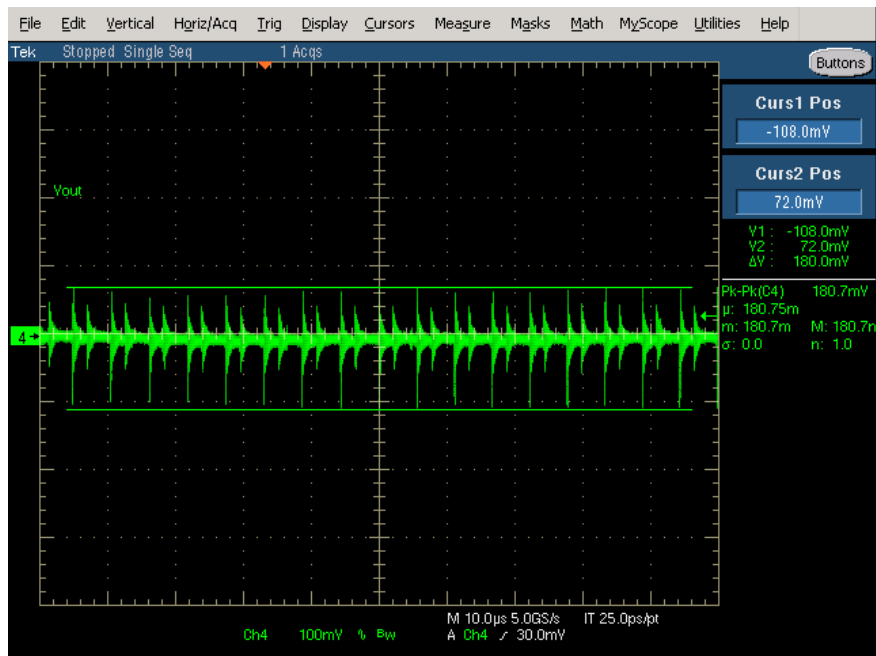

Figure 36. 115 Vac 15 Vout Ripple Zoom

# EVBUM2734/D

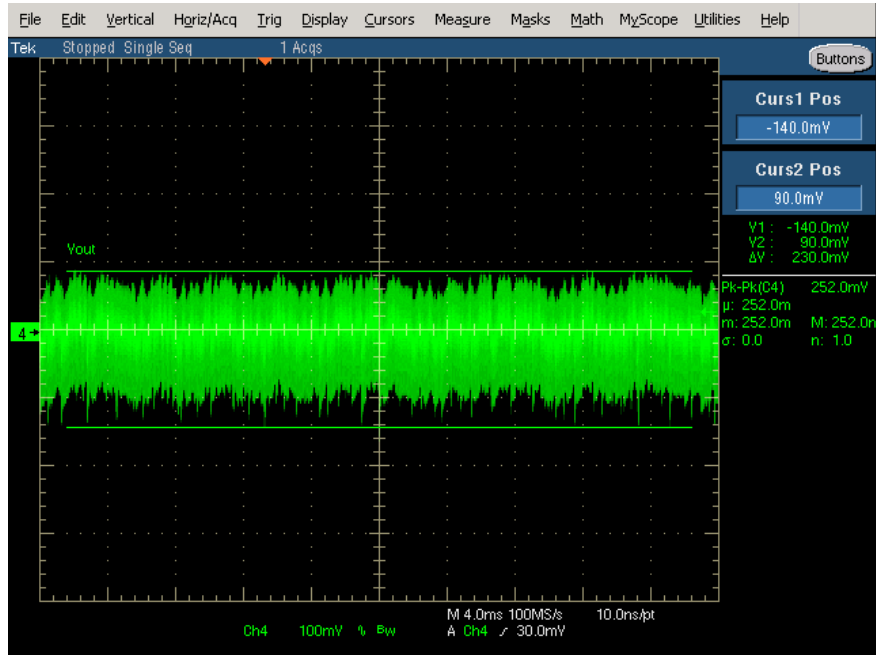

Figure 37. 230 Vac 15 Vout Ripple

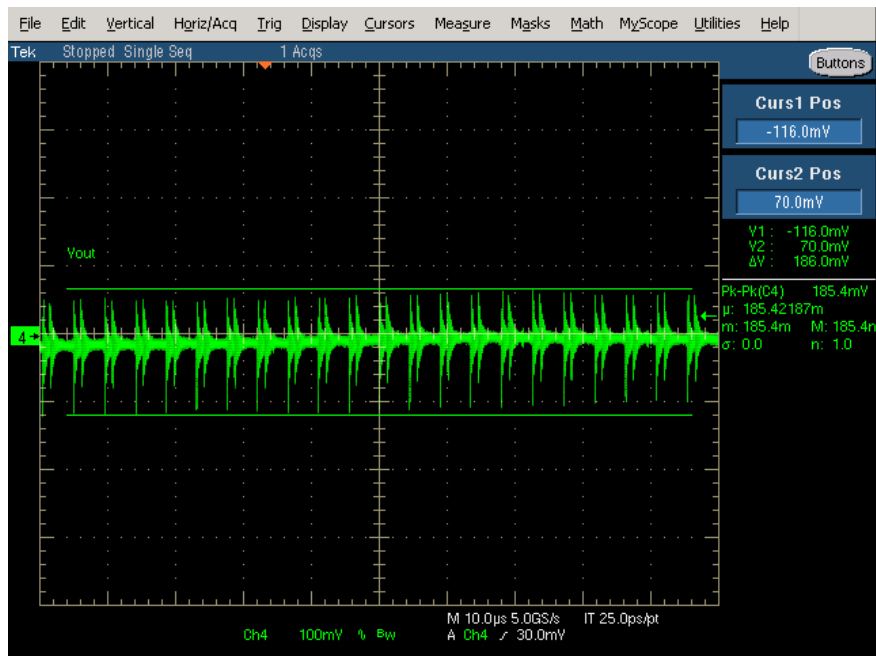

Figure 38. 230 Vac 15 Vout Ripple Zoom

# EVBUM2734/D

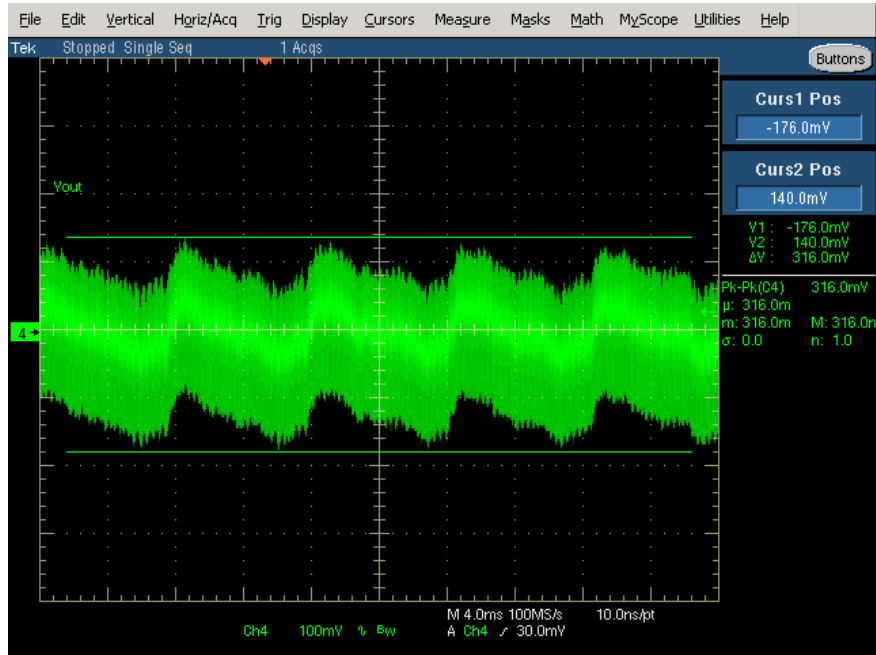

Figure 39. 115 Vac 20 Vout Ripple

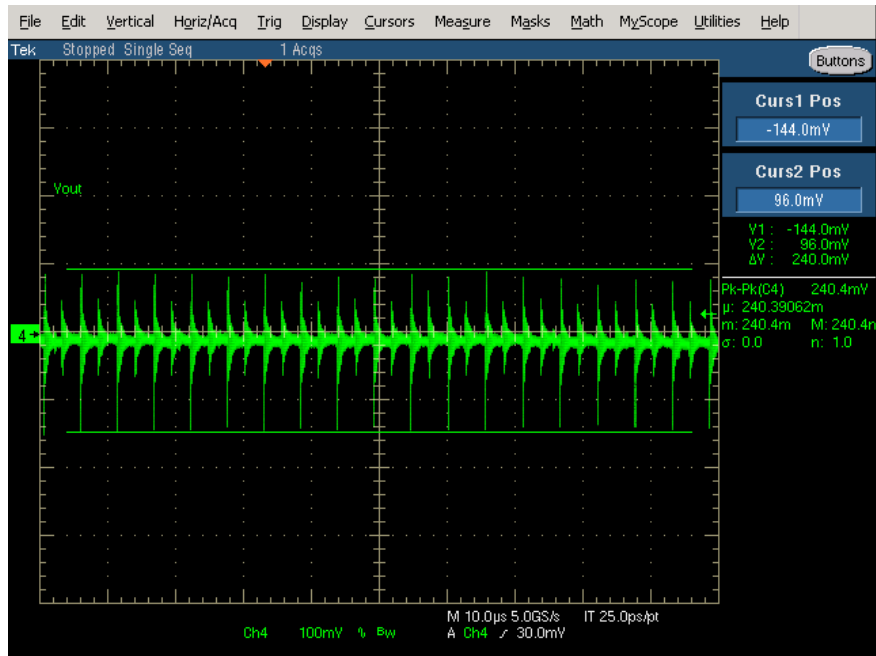

Figure 40. 115 Vac 20 Vout Ripple Zoom

# EVBUM2734/D

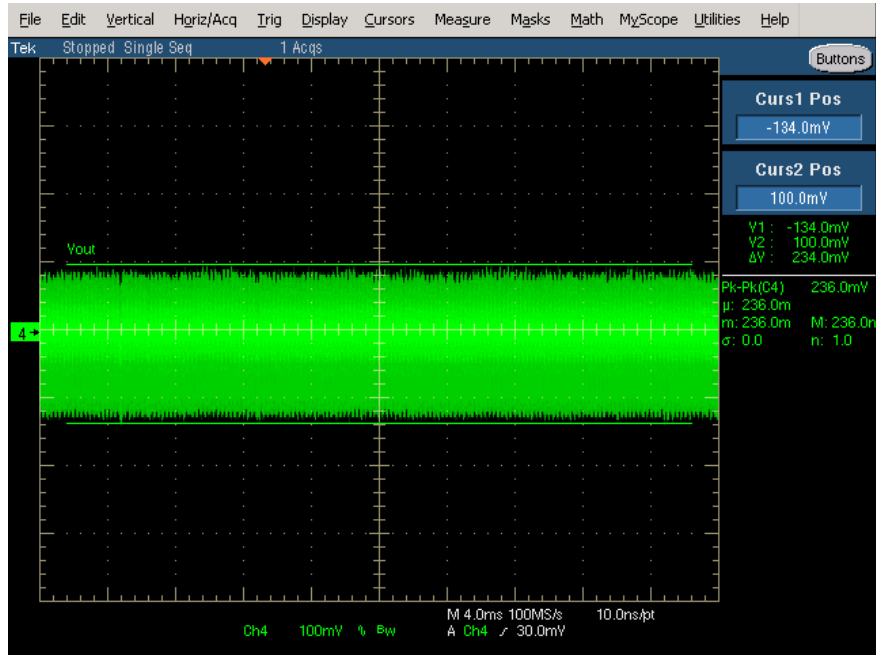

Figure 41. 230 Vac 20 Vout Ripple

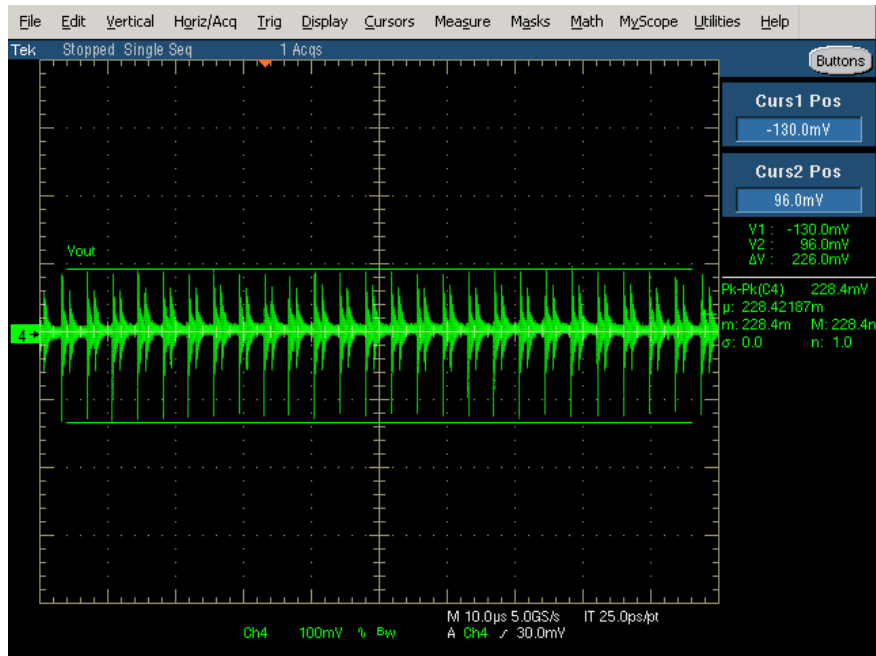

Figure 42. 230 Vac 20 Vout Ripple Zoom



# EVBUM2734/D

Transient Response (0.1 A – 3 A, 150 mA/μs, 20 ms)

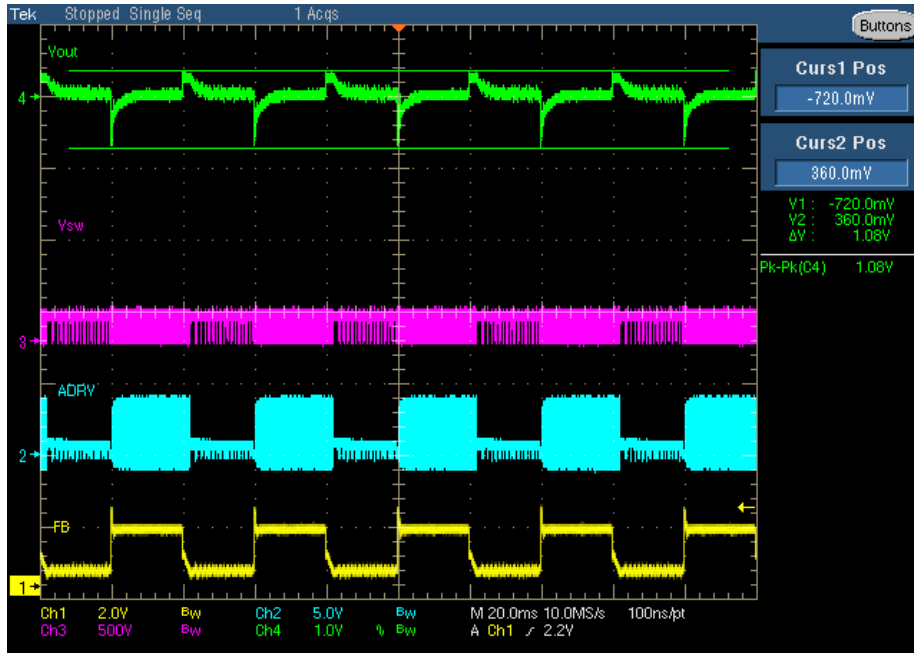

Figure 43. 115 Vac 5 Vout Transient

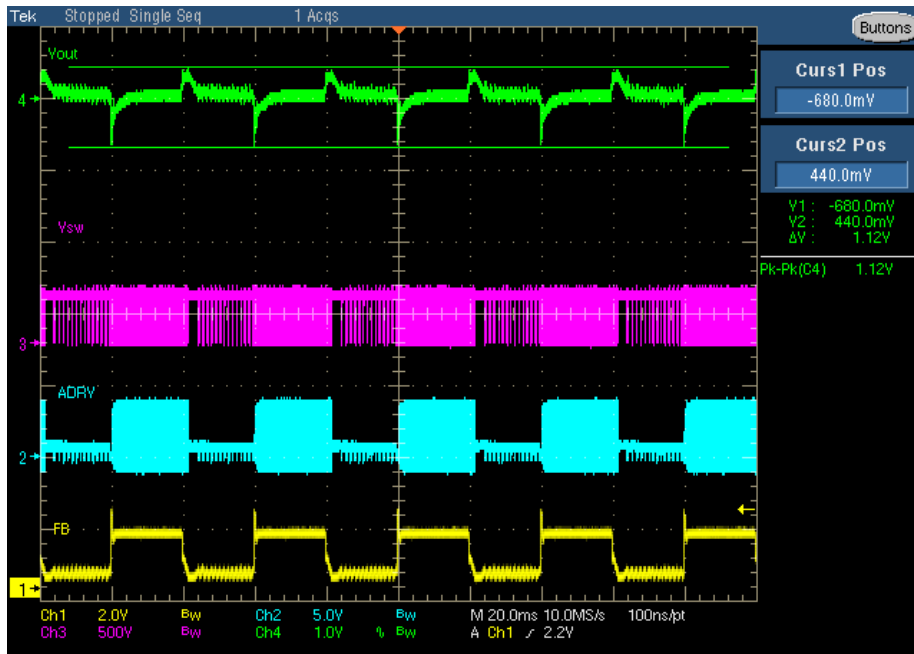

Figure 44. 230 Vac 5 Vout Transient

# EVBUM2734/D

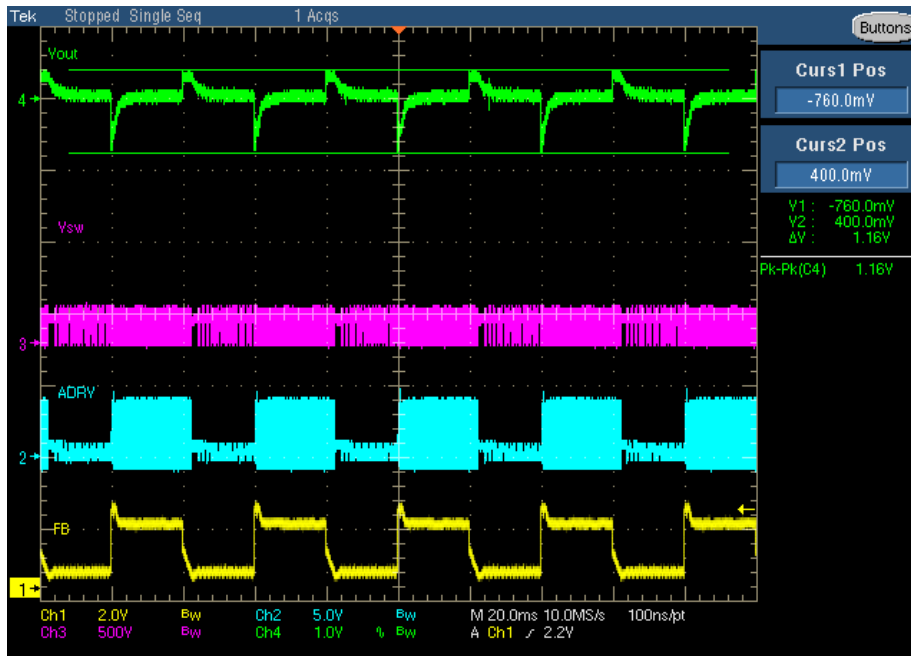

Figure 45. 115 Vac 9 Vout Transient

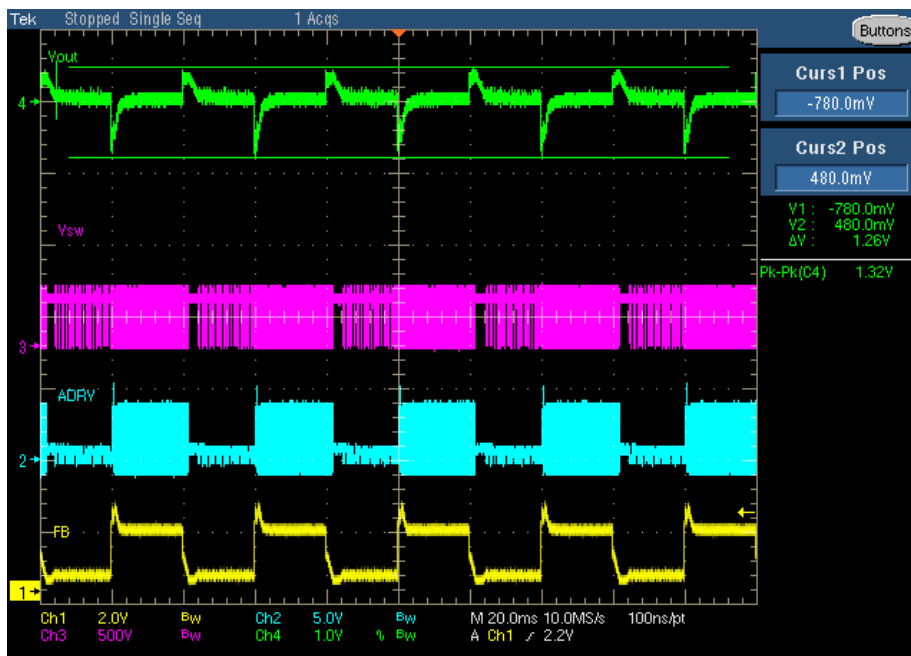

Figure 46. 230 Vac 9 Vout Transient

# EVBUM2734/D

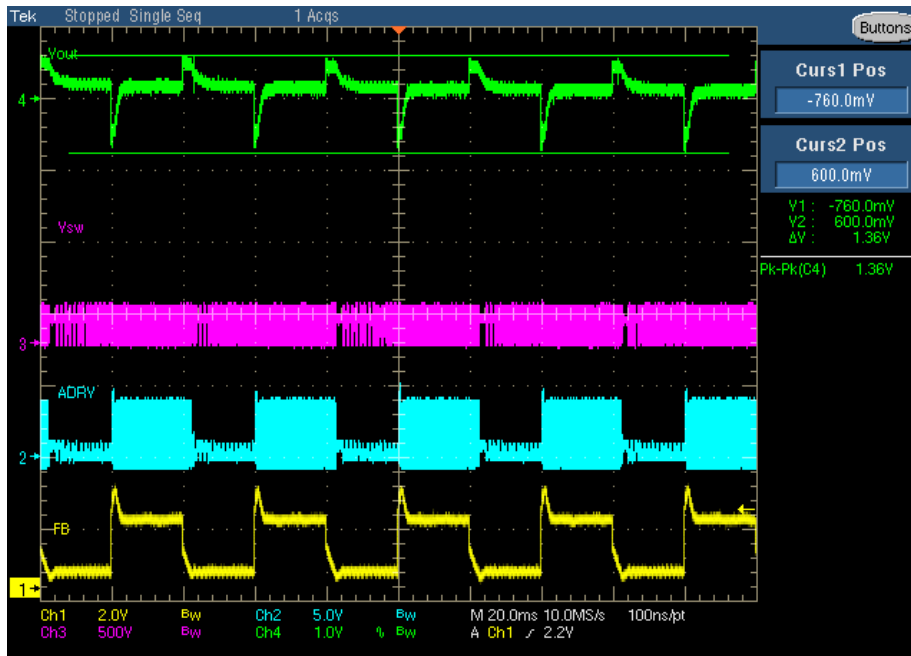

Figure 47. 115 Vac 12 Vout Transient



Figure 48. 230 Vac 12 Vout Transient

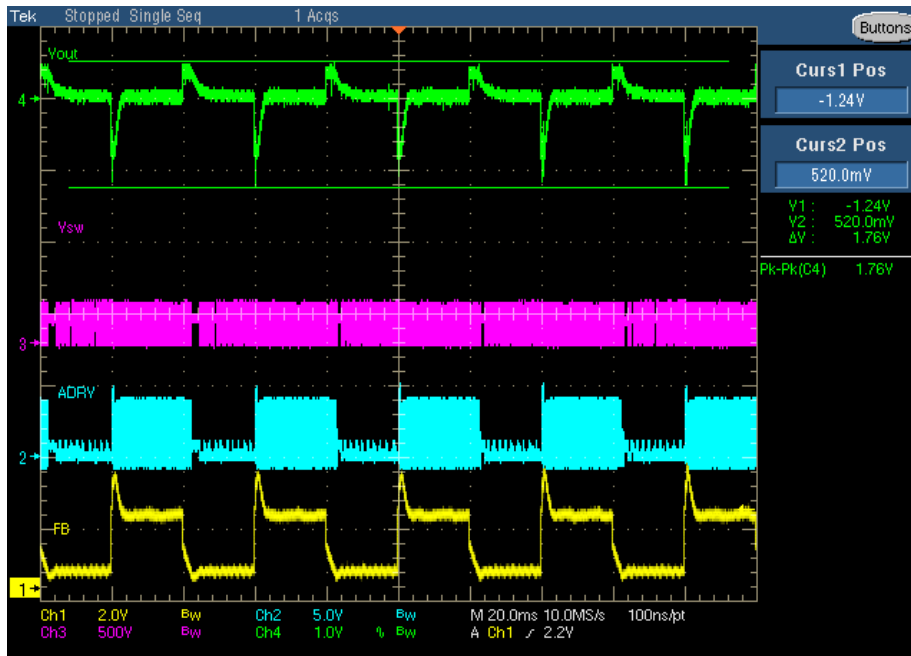

Figure 49. 115 Vac 15 Vout Transient

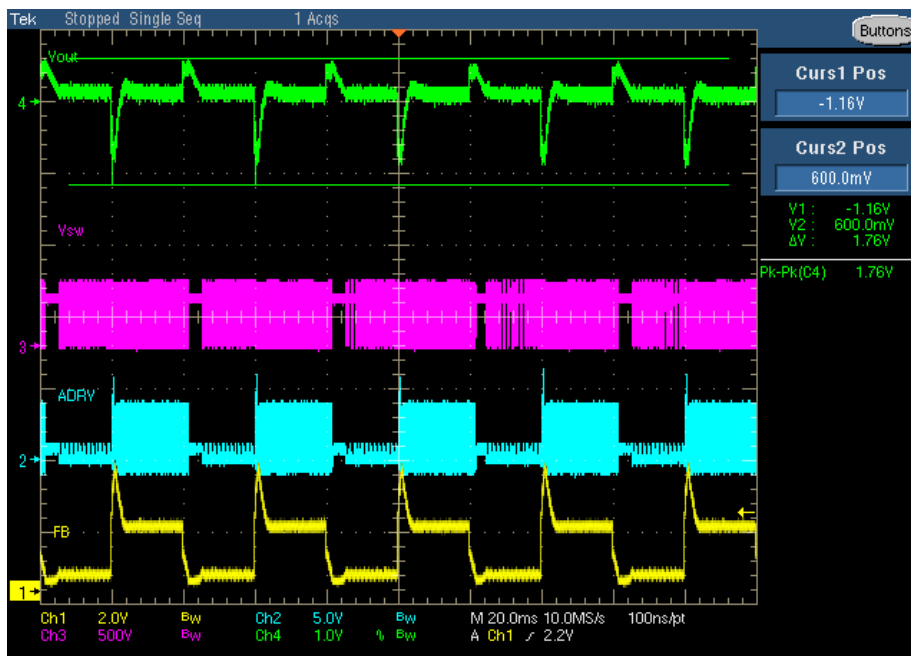

Figure 50. 230 Vac 15 Vout Transient

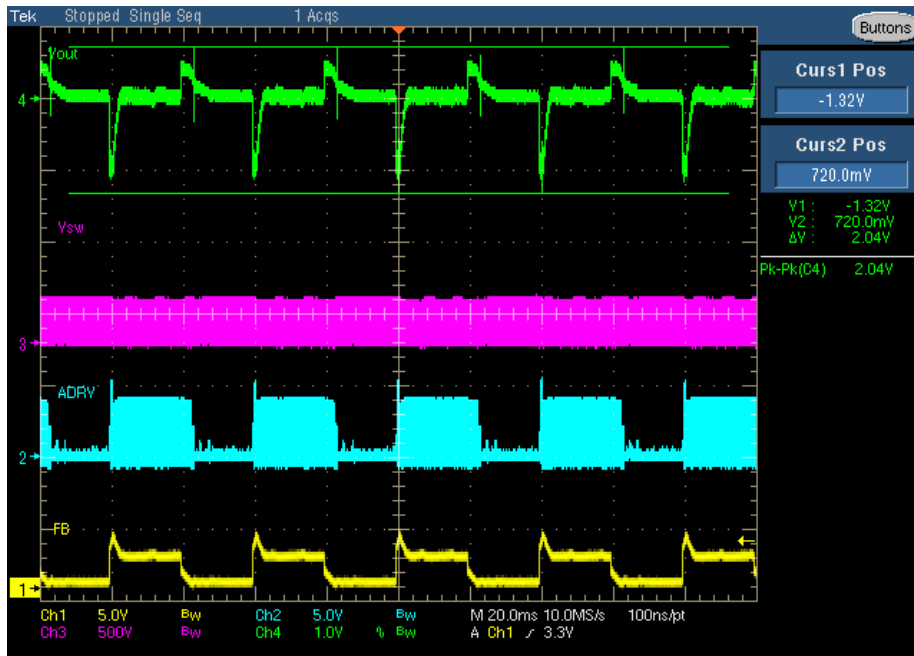

Figure 51. 115 Vac 20 Vout Transient

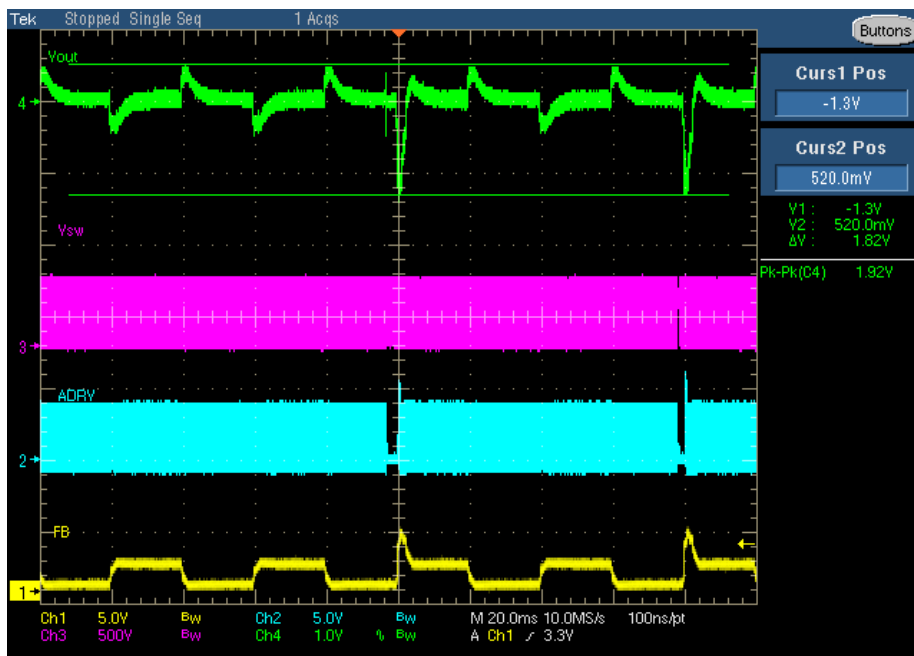

Figure 52. 230 Vac 20 Vout Transient

Tiny Load Data

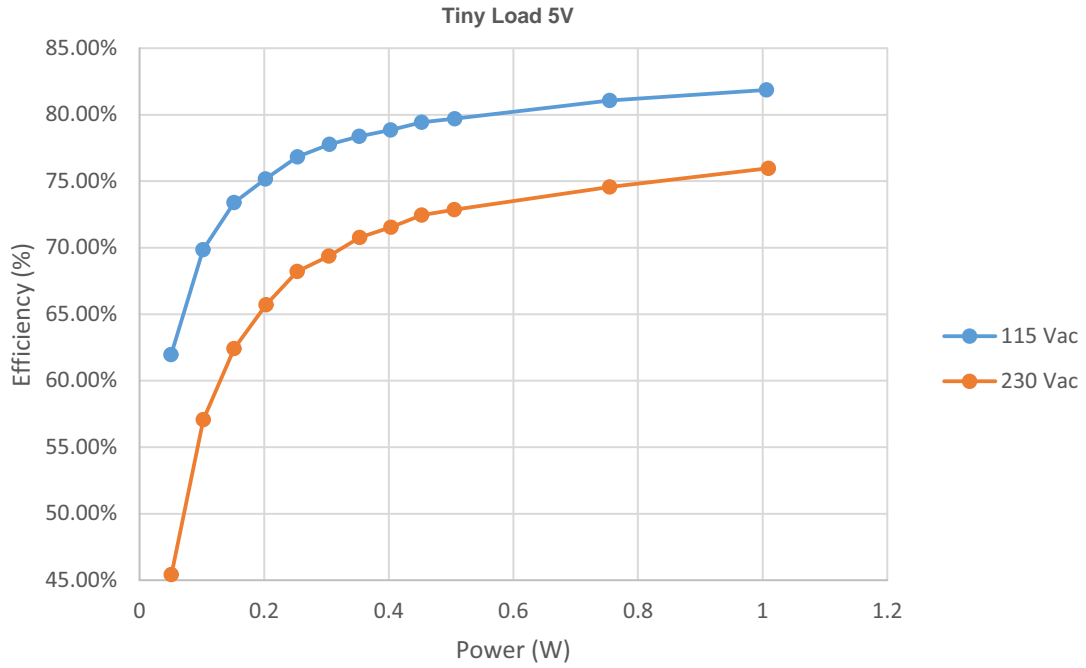

Figure 53. Tiny Load 5 V

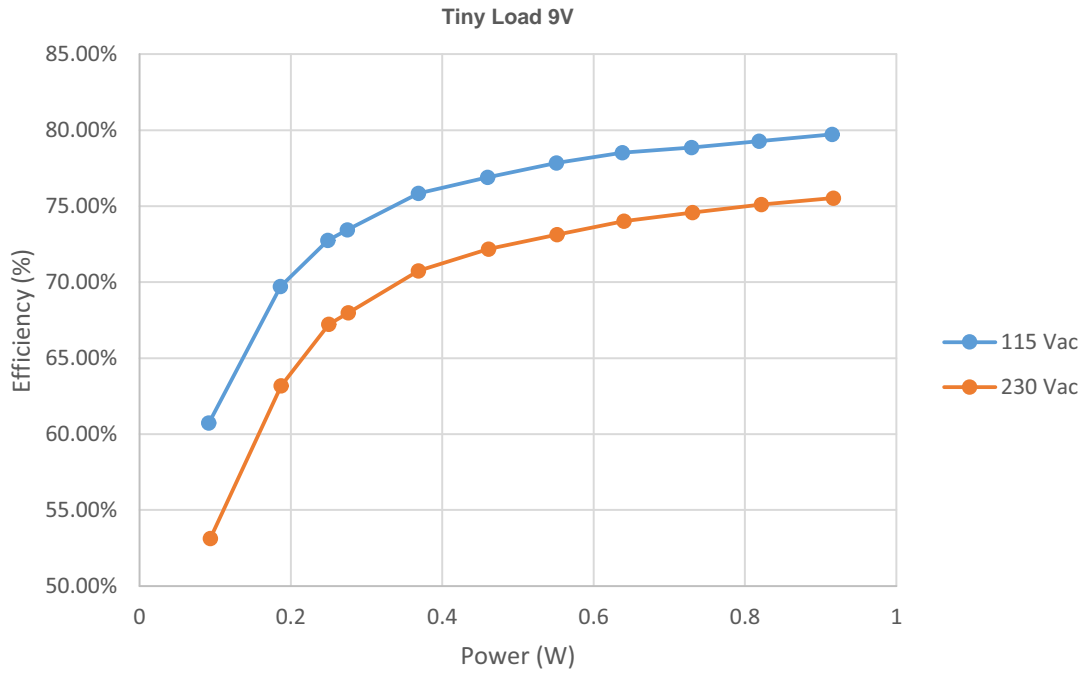

Figure 54. Tiny Load 9 V

# EVBUM2734/D

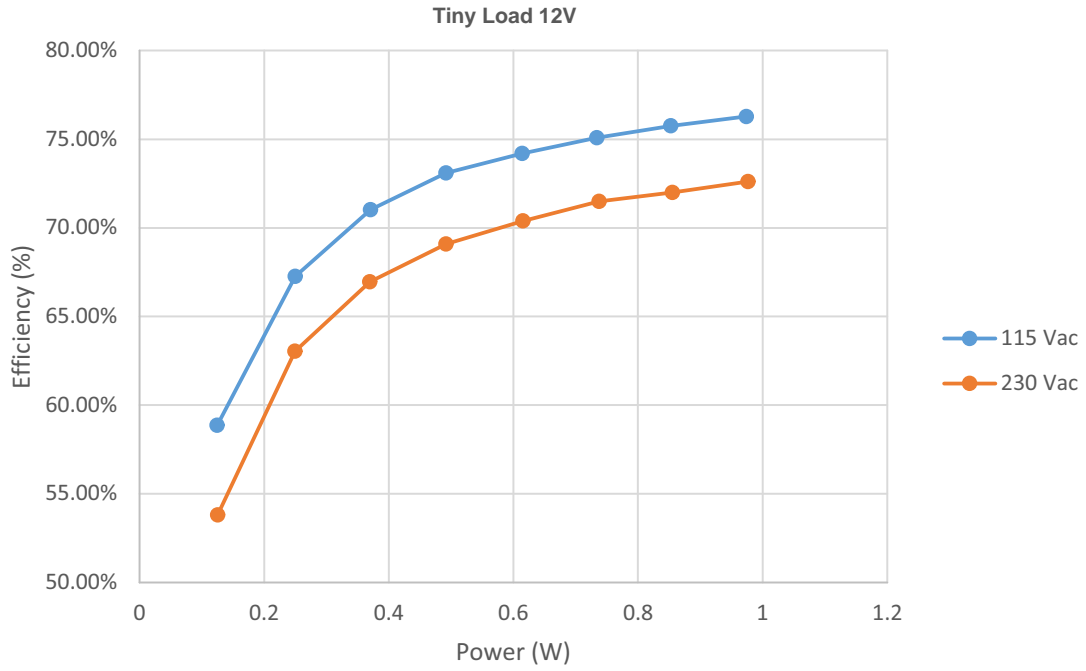

Figure 55. Tiny Load 12 V

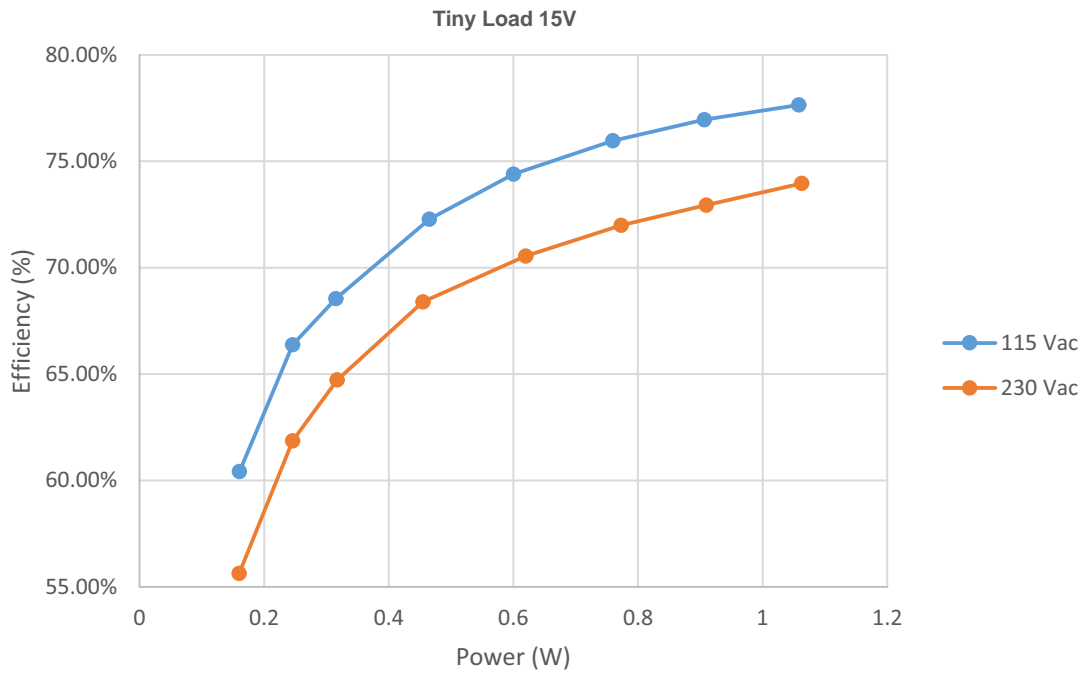

Figure 56. Tiny Load 15 V

# EVBUM2734/D

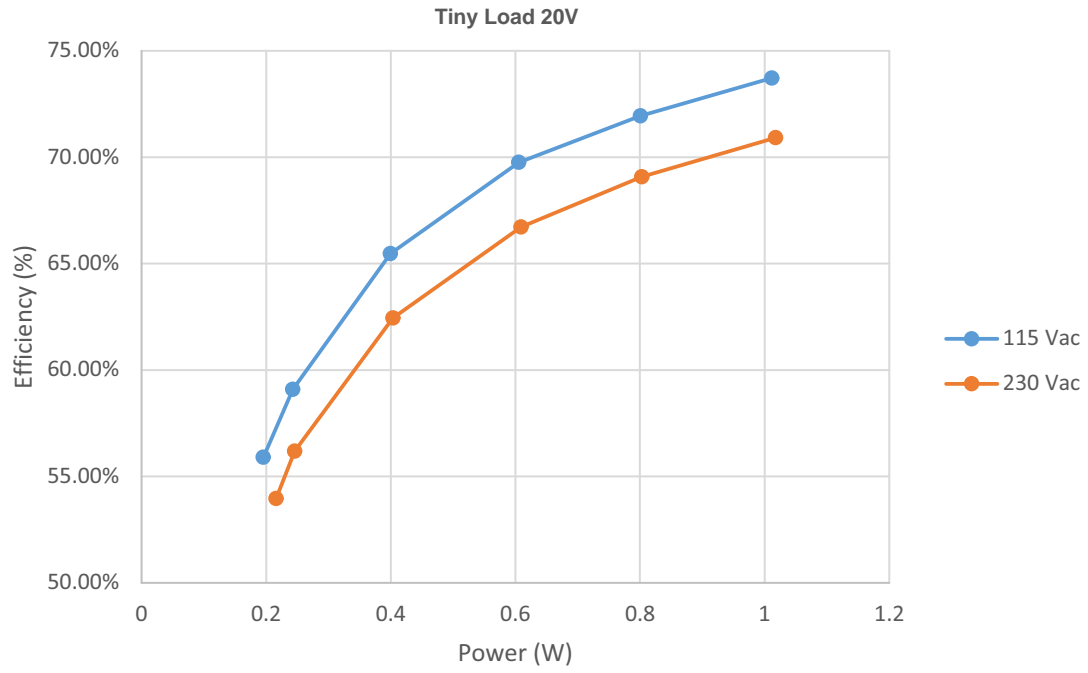
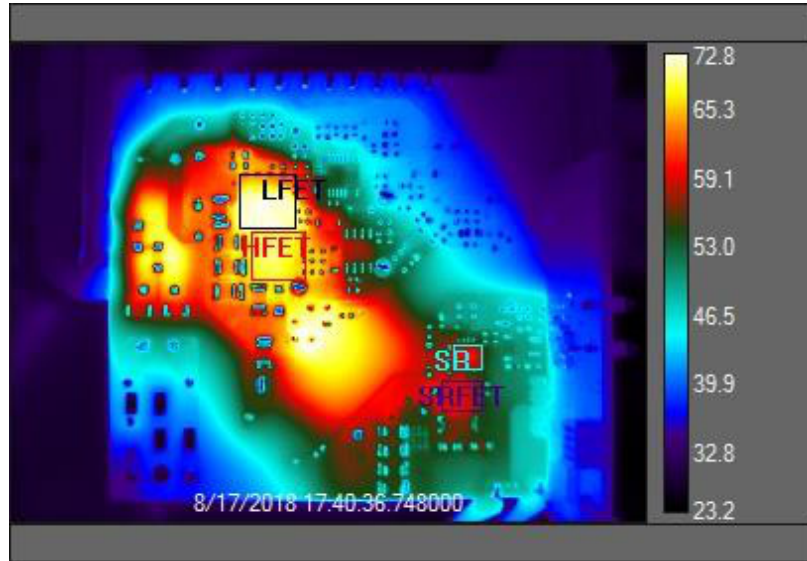

Figure 57. Tiny Load 20 V



Thermal Data, 115 Vac Full Load



Statistic [units]	LFET	HFET	SR	SRFET
Mean [°C]	68.9	67.2	58.5	57.9
Std. Dev. [°C]	3.0	2.3	1.0	1.5
Center [°C]	(129.0, 78.5) 71.2	(134.5, 106.0) 68.5	(230.0, 157.0) 59.9	(227.0, 176.5) 58.9
Maximum [°C]	(131, 91) 72.6	(133, 100) 69.2	(231, 157) 60.0	(225, 176) 59.2
Minimum [°C]	(142, 66) 57.0	(147, 101) 48.0	(233, 162) 55.8	(236, 178) 50.6

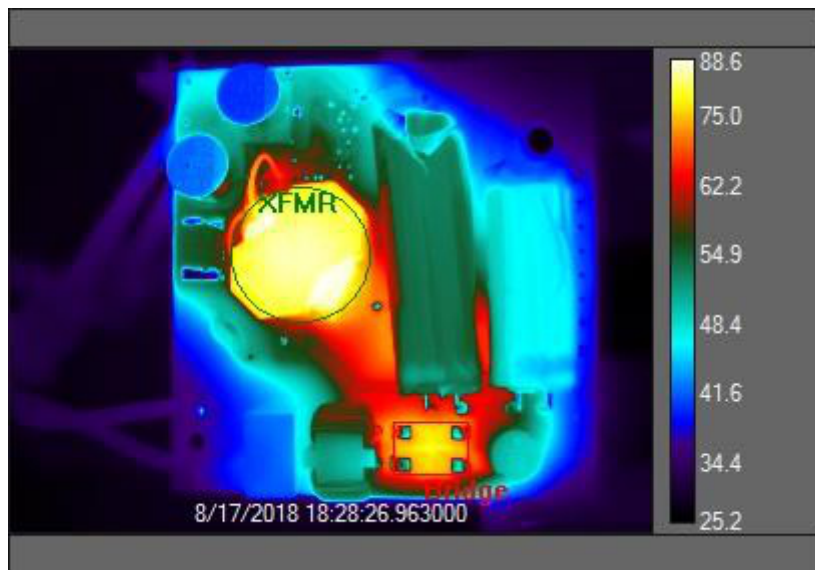

Statistic [units]	Bridge	XFMR
Mean [°C]	69.1	79.3
Std. Dev. [°C]	9.1	3.3
Center [°C]	(209.5, 198.0) 78.9	(144.5, 101.5) 80.7
Maximum [°C]	(209, 197) 78.9	(128, 85) 88.7
Minimum [°C]	(223, 192) 44.9	(112, 93) 59.7

Figure 58.

Thermal Data, 230 Vac Full Load

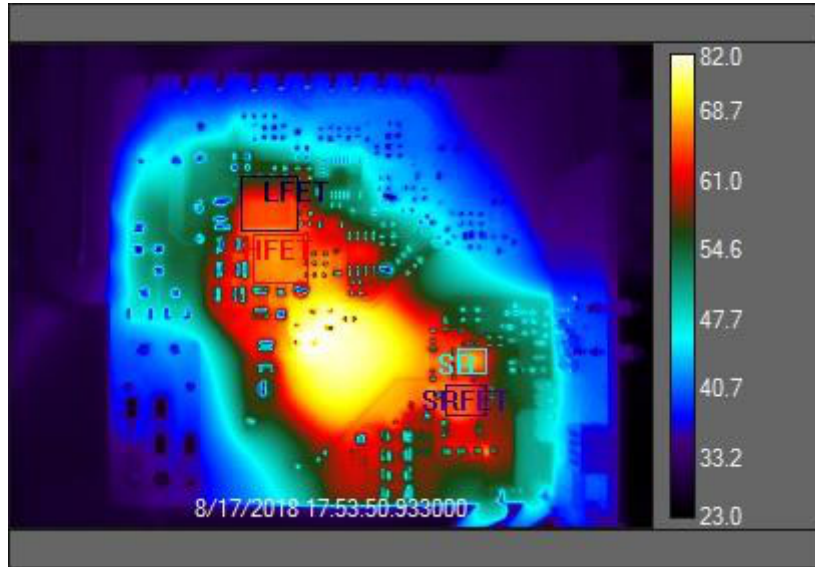

Statistic [units]	LFET	HFET	SR	SRFET
Mean [°C]	61.7	65.4	65.1	63.2
Std. Dev. [°C]	2.9	1.9	1.3	1.7
Center [°C]	(129.0, 78.5) 63.7	(134.5, 106.0) 66.4	(230.0, 157.0) 67.0	(227.0, 176.5) 64.3
Maximum [°C]	(131, 91) 66.0	(141, 117) 67.2	(231, 157) 67.1	(222, 180) 64.7
Minimum [°C]	(142, 66) 53.6	(147, 101) 47.9	(236, 162) 61.3	(236, 178) 55.0

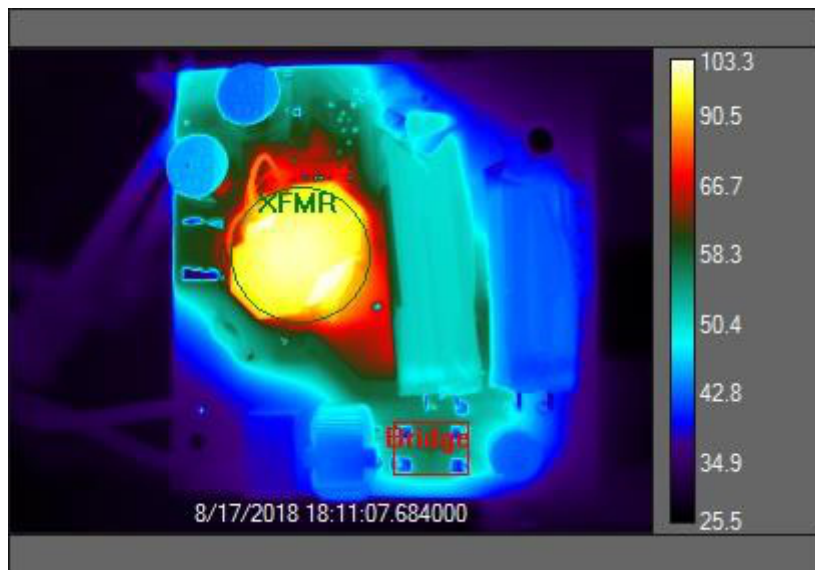

Statistic [units]	Bridge	XFMR
Mean [°C]	51.2	93.2
Std. Dev. [°C]	5.3	5.1
Center [°C]	(209.5, 198.0) 56.5	(144.5, 101.5) 96.2
Maximum [°C]	(192, 187) 57.9	(128, 85) 103.3
Minimum [°C]	(198, 192) 37.0	(112, 93) 65.7

Figure 59.

# EVBUM2734/D

## BILL OF MATERIALS – MAIN BOARD

Reference	Qty	Description	Value	Voltage Rating	Footprint	Manufacturer	Manufacturer Part Number
Q7	1	NMOSFET	60V 115mA		SOT-23-3	ON Semiconductor	2N7002L
R9 R25 R34-35 R38	5	SMT Resistor	0R0		603	Vishay	CRCW06030000Z0EA
R1	1	SMT Resistor	100k		603	Panasonic	ERJ-3EKF1003V
R17	1	SMT Resistor	10M		1206	Vishay	CRCW120610M0JNEA
R18 R21	2	SMT Resistor	10R0		603	Vishay	CRCW060310R0JNEAC
R6-7	2	SMT Resistor	10k		603	Vishay	CRCW060310K0FKEA
R19 R23	2	SMT Resistor	15R0		603	Vishay	CRCW060315R0FKEAHP
R39	1	SMT Resistor	15k		603	Vishay	CRCW060315K0FKEA
R8	1	SMT Resistor	1R0		603	Vishay	CRCW06031R00JNEA
R10	1	SMT Resistor	1k		603	Vishay	CRCW06031K00FKEA
R2-3	2	SMT Resistor	1k		1206	Vishay	CRCW12061K00JNEA
R44	1	SMT Resistor	2.49k		603	Vishay	CRCW06032K49FKEA
R36 R40	2	SMT Resistor	22R0		603	Vishay	CRCW060322R0FKEAC
R11	1	SMT Resistor	24.9k		603	Vishay	CRCW060324K9FKEA
R13	1	SMT Resistor	280k		603	Vishay	CRCW0603280KFKEAHP
R52	1	SMT Resistor	3.09k		603	Vishay	CRCW0603K09FKEA
R48	1	SMT Resistor	3.92k		603	Vishay	CRCW06033K92FKEAHP
R5	1	SMT Resistor	4.02M		603	Vishay	CRCW06034M02FKEA
R45	1	SMT Resistor	4.99k		603	Vishay	CRCW06034K99FKEAC
R4	1	SMT Resistor	44.2k		603	Vishay	CRCW060344K2FKEA
R26-29	4	SMT Resistor	499k		603	Vishay	CRCW0603499KFKEAHP
R24	1	SMT Resistor	604R		603	Vishay	CRCW0603604RFKEA
R12	1	SMT Resistor	82.5k		603	Vishay	CRCW060382K5FKEA
R14-15	2	SMT Resistor	DNI		603	Vishay	CRCW06036K65FKEA
R16	1	SMT Resistor	DNI		603	Vishay	CRCW06030000Z0EA
R30 R47	2	SMT Resistor	DNI		603		DNI
D9-11 D13	4	Schottky Barrier Diodes	100V	100V	SOD-123	ON Semiconductor	MMSD4148T3G
D4-7	4	Schottky Barrier Diodes	30V 1A	30V	SOD-123	ON Semiconductor	MBR130LSFT1G
D8	1	High Voltage Diode	600 V 1 A	600 V	SOD-123-2	ON Semiconductor	ES1JFL
Q4	1	PMOSFET	150V		SOT23	ON Semiconductor	FDN86265P
Q9	1	PMOSFET	50V		SOT23	ON Semiconductor	BSS84LT1G
C12 C14-16 C38 C40	6	SMT Ceramic Capacitor	0.1 uF	50V	603	TDK	C1608X7R1H104K080AA
C11	1	SMT Ceramic Capacitor	1.0uF	35V	603	TDK	C1608X5R1H105K080AB
C17 C24 C39	3	SMT Ceramic Capacitor	1.0uF	35V	603	TDK	C1608JB1H105K080AB
C35	1	SMT Ceramic Capacitor	10nF	50V	603	Kemet	C0603C103K5RACTU
C13 C25	2	SMT Ceramic Capacitor	120pF	50V	603	Kemet	C0603C121J5GACTU
C6	1	SMT Ceramic Capacitor	18pF	25V	603	Kemet	C0603C180K3GACTU

# EVBUM2734/D

## BILL OF MATERIALS – MAIN BOARD

 (continued)

Reference	Qty	Description	Value	Voltage Rating	Footprint	Manufacturer	Manufacturer Part Number
C3	1	SMT Ceramic Capacitor	1 nF	50 V	603	Murata	GCM188R71H102KA37D
C5	1	SMT Ceramic Capacitor	47 nF	50 V	603	TDK	CGA3E2X7R1H473K080A A
C26	1	SMT Ceramic Capacitor	DNP		603		
C32	1	SMT Capacitor	150 pF	200 V	805	AVX Corporation	08052A151JAT2A
C23	1	SMT Capacitor	1 μF	100 V	805	Taiyo Yuden	HMK212BC7105KG–TE
C34	1	SMT Capacitor	470 pF	200 V	805	KEMET	08052C471J2GACTU
C9–10	2	SMT Capacitor	0.10 μF	650 V	1210	TDK Corporation	CGA6L1X7T2J104K160AC
C18–21	4	SMT Capacitor	0.22 μF	450 V	1210	TDK Corporation	C3225X7T2W224K200AA
C1–2	2	Y Capacitors	DNP	250 Vac	1812		
C22	1	Aluminum Capacitor	68 μF	50 V	(6.3) mm	Panasonic	EEU–HD1H680B
C29–31 C33	4	Ceramic Capacitor SMT	22 μF	35 V	1206	TDK	C3216X5R1V226M160AC
C4	1	X2 capacitor	220 nF	275 Vac	(13 x 8 x 14.5) mm	Würth	890334023028
C36–37	2	Aluminum Polymer Cap	470 μF / 25 V	25 V	(10.3 x 10.3 x 12.8) mm	Nichicon	25SVPK470M
D1–3	3	High Voltage Diode	600 V 1 A	600 V	SOD–123–2	ON Semiconductor	ES1JFL
PRIREG	1	SIP Header	2		Through Hole	Würth	61300211021
SEC_REG	1	SIP Header	2		Through Hole	Würth Electronics Inc.	61300411021
Q2	1	600V MOSFET	600 V 9 A	600 V	ThinPak 8X8	Infineon Technologies	IPL60R385CPAUMA1
Q3	1	600V MOSFET	600 V 9 A	600 V	ThinPak 8X8	Infineon Technologies	IPL60R299CP
C28	1	Y Capacitors	150 pF	30 Vac	Radial, Disc	Murata	DE1B3KX151KN4AP01F
C27	1	Y Capacitors	470 pF	250 Vac	Radial, Disc	Murata	DE2B3KY471KN3AM02F
D12	1	Schottky Diodes	150 V 2 A	150 V	SMA	STMicroelectronics	STPS2150A
C7	1	Aluminum Capacitor	47 μF	400 V	(12.1X33.5) mm	Nichicon	UPZ2G470MHD
C8	1	Aluminum Capacitor	82 μF	400 V	(12.1X42) mm	Rubycon	400BXW82MEFCG412.5X 40
F1	1	FAST FUSE 2	3.15 A		(8.5x4x8) mm	Littelfuse Inc.	39213150000
BD1	1	Bridge Rectifier	600 V / 4 A	600 V	4–SMD	ZOWIE	Z4GP40KH
T2	1	Common Mode Choke	6.5 mH 70 mΩ		(15X12X15) mm	KEMET	SCF–03–650
L3	1	SMT Inductor	10 μH		8.2 mm	Würth	744772100
L1	1	SMT Inductor	2 μH		(6.90x6.90)	Würth	744314200
E	1	Green Test Point			Through Hole	E–Mark Inc	01–1036

# EVBUM2734/D

## BILL OF MATERIALS – MAIN BOARD

 (continued)

Reference	Qty	Description	Value	Voltage Rating	Footprint	Manufacturer	Manufacturer Part Number
L	1	White Test Point			Through Hole	E-Mark Inc	01-1013
N	1	Black Test Point			Through Hole	E-Mark Inc	01-1015
Q6 Q10	2	Dual npn Transistor	40 V 200 mA		SOT-363	ON Semiconductor	MBT3904DW1T1G
Q5	1	NPN Transistor	80 V 200 mA	40 V	SOT-23-3	ON Semiconductor	BSS64LT1G
Q1	1	PNP BJT	DNI		SOT-23-3	ON Semiconductor	DNI
Z2	1	Zener Diode	12 V		SOD-323	ON Semiconductor	MM3Z12VB
Z6	1	Zener Diode	12 V 500 mW		SOD-323	ON Semiconductor	MM3Z12VB
Z1	1	Zener Diode	18 V 500 mW		SOD-323	ON Semiconductor	MM3Z18VC
Z5	1	Zener Diode	4.7 V 500 mW		SOD-123	ON Semiconductor	MMSZ5230BT1G
Z3	1	Zener Diode	6.2 V		SOD-323	ON Semiconductor	MM3Z6V2C
Z4	1	Zener Diode	DNI		SOD-323	ON Semiconductor	MM3Z5V1C
Q8	1	Power NFET	120 V 11 mΩ	120 V	SOIC8_FL	ON Semiconductor	FDMS86202
U1	1	ACF PWM Controller	700 V 2 A	30 V	Tssop 16	ON Semiconductor	NCP1568S02DBR2G
U3	1	Sync Rec	20 V		DFN8	ON Semiconductor	NCP4305DMNTWG
U2	1	H Bridge Driver	600 V 1.9 A	20 V	SOIC-8	ON Semiconductor	NCP51530ADR2G
RT1	1	SMT Resistor	220k		603	Murata Electronics North America	NCP18WM224J03RB
R46	1	SMT Resistor	0R0		402	Vishay	CRCW04020000Z0EDHP
R43	1	SMT Resistor	DNI		402	Panasonic	ERJ-2GE0R00X
R49-50	2	SMT Resistor	4.99k		603	Vishay	CRCW06034K99FKEAC
R20 R22 R31 R42 R51	5	SMT Resistor	49.9k		603	Vishay	CRCW060349K9FKEAC
R37	1	SMT Resistor	499R		603	Stackpole	RMCF0603FT499R
R41	1	SMT Resistor	100R		805	Vishay	CRCW0805100RJNEAC
R32-33	2	SMT Resistor	500 m		805	Susumu	RL1220S-R50-F
F1S SIS	2	RM8 T1 Connection					
F2S S2S	2	RM8 T1 Connection					
T1	1	Transformer	120 uH 6:1 / Material: ML29D		RM8LP	Würth w/ Hitachi Metals	750317295
ADRV ATH VSW	3	Blue Test Point			Through Hole	E-Mark Inc	01-1017
DTH FB FLT LGATE RT CS	6	White Test Point			Through Hole	E-Mark Inc	01-1013
GND4 GND_S GND1-3	5	Black Test Point			Through Hole	E-Mark Inc	01-1015

# EVBUM2734/D

## BILL OF MATERIALS – MAIN BOARD (continued)

Reference	Qty	Description	Value	Voltage Rating	Footprint	Manufacturer	Manufacturer Part Number
VCC VOUT	2	Red Test Point			Through Hole	E-Mark Inc	01-1178
HV	1	Yellow Test Point			Through Hole	E-Mark Inc	01-1013

**onsemi**, **Onsemi**, and other names, marks, and brands are registered and/or common law trademarks of Semiconductor Components Industries, LLC dba "**onsemi**" or its affiliates and/or subsidiaries in the United States and/or other countries. **onsemi** owns the rights to a number of patents, trademarks, copyrights, trade secrets, and other intellectual property. A listing of **onsemi**'s product/patent coverage may be accessed at [www.onsemi.com/site/pdf/Patent-Marking.pdf](http://www.onsemi.com/site/pdf/Patent-Marking.pdf). **onsemi** is an Equal Opportunity/Affirmative Action Employer. This literature is subject to all applicable copyright laws and is not for resale in any manner.

The evaluation board/kit (research and development board/kit) (hereinafter the "board") is not a finished product and is not available for sale to consumers. The board is only intended for research, development, demonstration and evaluation purposes and will only be used in laboratory/development areas by persons with an engineering/technical training and familiar with the risks associated with handling electrical/mechanical components, systems and subsystems. This person assumes full responsibility/liability for proper and safe handling. Any other use, resale or redistribution for any other purpose is strictly prohibited.

**THE BOARD IS PROVIDED BY ONSEMI TO YOU "AS IS" AND WITHOUT ANY REPRESENTATIONS OR WARRANTIES WHATSOEVER. WITHOUT LIMITING THE FOREGOING, ONSEMI (AND ITS LICENSORS/SUPPLIERS) HEREBY DISCLAIMS ANY AND ALL REPRESENTATIONS AND WARRANTIES IN RELATION TO THE BOARD, ANY MODIFICATIONS, OR THIS AGREEMENT, WHETHER EXPRESS, IMPLIED, STATUTORY OR OTHERWISE, INCLUDING WITHOUT LIMITATION ANY AND ALL REPRESENTATIONS AND WARRANTIES OF MERCHANTABILITY, FITNESS FOR A PARTICULAR PURPOSE, TITLE, NON-INFRINGEMENT, AND THOSE ARISING FROM A COURSE OF DEALING, TRADE USAGE, TRADE CUSTOM OR TRADE PRACTICE.**

**onsemi** reserves the right to make changes without further notice to any board.

You are responsible for determining whether the board will be suitable for your intended use or application or will achieve your intended results. Prior to using or distributing any systems that have been evaluated, designed or tested using the board, you agree to test and validate your design to confirm the functionality for your application. Any technical, applications or design information or advice, quality characterization, reliability data or other services provided by **onsemi** shall not constitute any representation or warranty by **onsemi**, and no additional obligations or liabilities shall arise from **onsemi** having provided such information or services.

**onsemi** products including the boards are not designed, intended, or authorized for use in life support systems, or any FDA Class 3 medical devices or medical devices with a similar or equivalent classification in a foreign jurisdiction, or any devices intended for implantation in the human body. You agree to indemnify, defend and hold harmless **onsemi**, its directors, officers, employees, representatives, agents, subsidiaries, affiliates, distributors, and assigns, against any and all liabilities, losses, costs, damages, judgments, and expenses, arising out of any claim, demand, investigation, lawsuit, regulatory action or cause of action arising out of or associated with any unauthorized use, even if such claim alleges that **onsemi** was negligent regarding the design or manufacture of any products and/or the board.

This evaluation board/kit does not fall within the scope of the European Union directives regarding electromagnetic compatibility, restricted substances (RoHS), recycling (WEEE), FCC, CE or UL, and may not meet the technical requirements of these or other related directives.

FCC WARNING – This evaluation board/kit is intended for use for engineering development, demonstration, or evaluation purposes only and is not considered by **onsemi** to be a finished end product fit for general consumer use. It may generate, use, or radiate radio frequency energy and has not been tested for compliance with the limits of computing devices pursuant to part 15 of FCC rules, which are designed to provide reasonable protection against radio frequency interference. Operation of this equipment may cause interference with radio communications, in which case the user shall be responsible, at its expense, to take whatever measures may be required to correct this interference.

**onsemi** does not convey any license under its patent rights nor the rights of others.

LIMITATIONS OF LIABILITY: **onsemi** shall not be liable for any special, consequential, incidental, indirect or punitive damages, including, but not limited to the costs of requalification, delay, loss of profits or goodwill, arising out of or in connection with the board, even if **onsemi** is advised of the possibility of such damages. In no event shall **onsemi**'s aggregate liability from any obligation arising out of or in connection with the board, under any theory of liability, exceed the purchase price paid for the board, if any.

The board is provided to you subject to the license and other terms per **onsemi**'s standard terms and conditions of sale. For more information and documentation, please visit [www.onsemi.com](http://www.onsemi.com).

## PUBLICATION ORDERING INFORMATION

### LITERATURE FULFILLMENT:

Email Requests to: [orderlit@onsemi.com](mailto:orderlit@onsemi.com)

**onsemi Website:** [www.onsemi.com](http://www.onsemi.com)

### TECHNICAL SUPPORT

**North American Technical Support:**

Voice Mail: 1 800-282-9855 Toll Free USA/Canada

Phone: 011 421 33 790 2910

**Europe, Middle East and Africa Technical Support:**

Phone: 00421 33 790 2910

For additional information, please contact your local Sales Representative